

&Tradition The Lighting Collection 2024

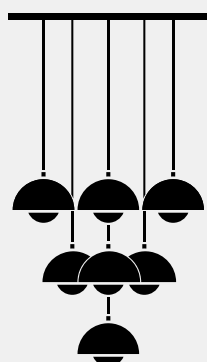
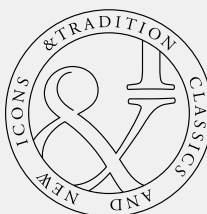
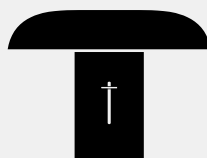

Price list 2024 – Valid from February 1st
Currency: EURO ex. Vat

Alle Preise zzgl. ges. MwSt.

Lighting



Flowerpot ^{VP10}

Design Verner Panton | 1968
Category Pendant
Variants Lacquered or plated steel
Price* from 170 EUR

p. 16

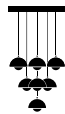

Flowerpot Chandelier ^{VP10}

Design Verner Panton | 1968
Category Chandelier
Variants Lacquered aluminium for 10 or 31 pendants
Price* from 2.039 EUR

p. 17

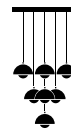

Flowerpot Chandelier ^{VP1}

Design Verner Panton | 1968
Category Chandelier
Variants Lacquered aluminium for 10 or 31 pendants
Price* from 2.493 EUR

p. 19

NEW VARIANT

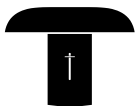

Montera ^{JH42}

Design Jaime Hayon | 2024
Category Table lamp
Variants Forest/Sky or Amber/Ruby
Price* 454 EUR

p. 34



Como ^{SC53}

Design Space Copenhagen | 2020
Category Portable lamp
New Aluminium
Variants
Price* 170 EUR

p. 39

Index

Lighting

| | | | | | | |
|------------------------------|--------------------|--------------------|------|-------------------|-----|-----|
| P376 p. 6 | KF1 | KF2 | | | | |
| Blown p. 7 | SW3 | SW4 | SW5 | | | |
| Passepartout p. 8 | JH10 | JH11 | JH12 | | | |
| Tabata p. 9 | LN10 | | | | | |
| Colette p. 10 | ATD6 | | | | | |
| Formakami p. 11 | JH3 | JH4 | JH5 | JH18 | | |
| Setago p. 12 | JH27 | | | | | |
| Bellevue p. 13-15 | AJ7 | AJ9 | AJ11 | | | |
| Flowerpot p. 16-21 | VP10 NEW | VP10 NEW | VP1 | VP1 NEW | VP7 | VP2 |
| Flowerpot p. 22-25 | VP3 | VP4 | VP8 | VP9 | | |
| Topan p. 26 | VP6 | | | | | |
| Utzon Lamp p. 27 | JU1 | | | | | |
| Copenhagen p. 28 | SC6 | SC7 | SC8 | | | |
| Copenhagen p. 29 | SC13 | SC14 | | | | |
| Spinning p. 30 | BH1 | BH2 | | | | |
| Mega Bulb p. 31 | SR2 | | | | | |
| Journey p. 32 | SHY1 | SHY2 | | | | |
| Herman p. 33 | SHY3 | | | | | |

Index

Montera JH42
p. 34 NEW

Tripod HM8 HM9
p. 35

Mist AP15 AP16 AP17
p. 36

Lucca SC51
p. 37

Manhattan SC52
p. 38

Como SC53
p. 39

Caret MF1
p. 40

Raku SH8
p. 41

Pivot ATD7
p. 42

Index

Product information

Spare Parts
p. 43-45

Material care and cleaning
p. 46-49

Colour Overview
p. 50

Packaging Information
p. 51-52

Sales procedures for dealers
p. 53-54

Information regarding lead times

Kindly note that lead times are stated excluding transport from the &Tradition warehouse.

P376 KF1 & KF2

Kastholm & Fabricius

1963

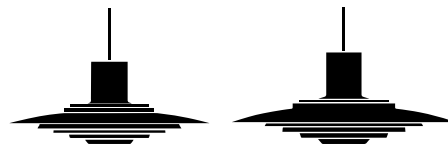

| Item no. | Product | Product code | Variant | Cord | Colli qty. | Lead time | Weight | PRICE EX. VAT (EUR) |
|----------|--------------|--------------|------------|------------------|------------|------------|---------|---------------------|
| 12010099 | P376 Pendant | KF1 | Aluminium | 4m Black textile | 1 pc | Stock item | 3.70 kg | 545 |
| 12010031 | P376 Pendant | KF1 | Matt White | 4m White textile | 1 pc | Stock item | 3.70 kg | 545 |
| 12020099 | P376 Pendant | KF2 | Aluminium | 6m Black textile | 1 pc | Stock item | 7.00 kg | 1.021 |
| 12020031 | P376 Pendant | KF2 | Matt White | 6m White textile | 1 pc | Stock item | 7.00 kg | 1.021 |

Technical Specification

KF1:
E27 Max 100 Watt

KF2:
E27 Max 150 Watt

Material: Lacquered aluminium.

Bulb is not included.
Canopy included

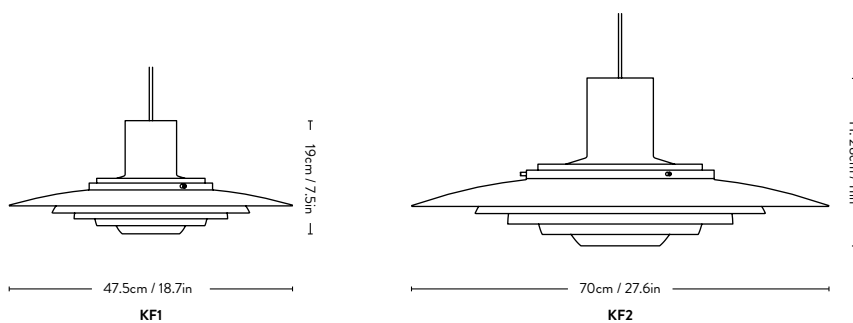

Blown ^{SW3-SW5} Samuel Wilkinson 2014, 2018 & 2019

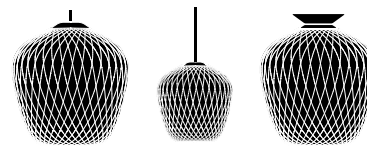

| Item no. | Product | Product code | Variant | Cord | Colli qty. | Lead time | Weight | PRICE EX. VAT (EUR) |
|----------|---------|--------------|---------------|------------------|------------|------------|---------|---------------------|
| 20630594 | Blown | SW3 | Silver Lustre | 4m Black textile | 2 pcs | Stock item | 4.10 kg | 306 |
| 20641094 | Blown | SW4 | Silver Lustre | 4m Black textile | 2 pcs | Stock item | 2.30 kg | 238 |
| 20651094 | Blown | SW5 | Silver Lustre | N/A | 2 pcs | Stock item | 2.60 kg | 306 |

Technical Specification

SW3: E27 Max 60 Watt
 SW4: E14 Max 40 Watt
 SW5: E27 Max 60 Watt

Material: Mouth blown glass and powder coated metal.

Bulb is not included.
 Black canopy is included for pendants.

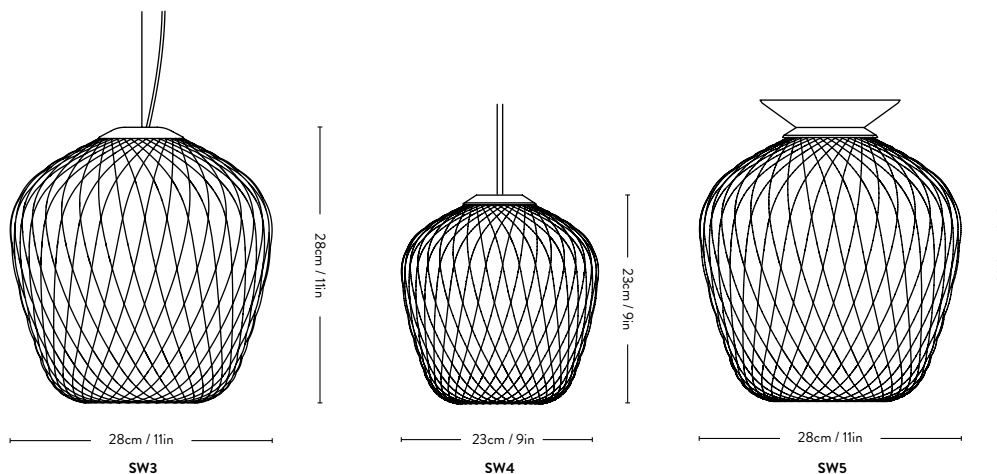

Passepartout^{JH10-JH12} Jaime Hayon 2016



| Item no. | Product | Product code | Variant | Colli qty. | Lead time | Weight | PRICE EX. VAT (EUR) |
|----------|--------------|--------------|---------|------------|------------|---------|---------------------|
| 83401197 | Passepartout | JH10 | Bronzed | 1 pc | Stock item | 0.65 kg | 283 |
| 83401191 | Passepartout | JH10 | Gold | 1 pc | Stock item | 0.65 kg | 283 |
| 83401297 | Passepartout | JH11 | Bronzed | 1 pc | Stock item | 0.75 kg | 283 |
| 83401291 | Passepartout | JH11 | Gold | 1 pc | Stock item | 0.75 kg | 283 |
| 83401397 | Passepartout | JH12 | Bronzed | 1 pc | Stock item | 0.95 kg | 283 |
| 83401391 | Passepartout | JH12 | Gold | 1 pc | Stock item | 0.95 kg | 283 |

Technical Specification

11.5 Watt LED board, dimmable
 CRI: > 90
 Colour temperature (Kelvin): 2100-2700K
 Light output: JH10: 350 lumen
 JH11: 520 lumen
 JH12: 600 lumen
 Dimmability: Dim-to-warm
 IP class: IP20

Material: Aluminium, polycarbonate, ABS.

This product contains a light source of energy efficiency class F.
 LED board included – replaceable (spare part).

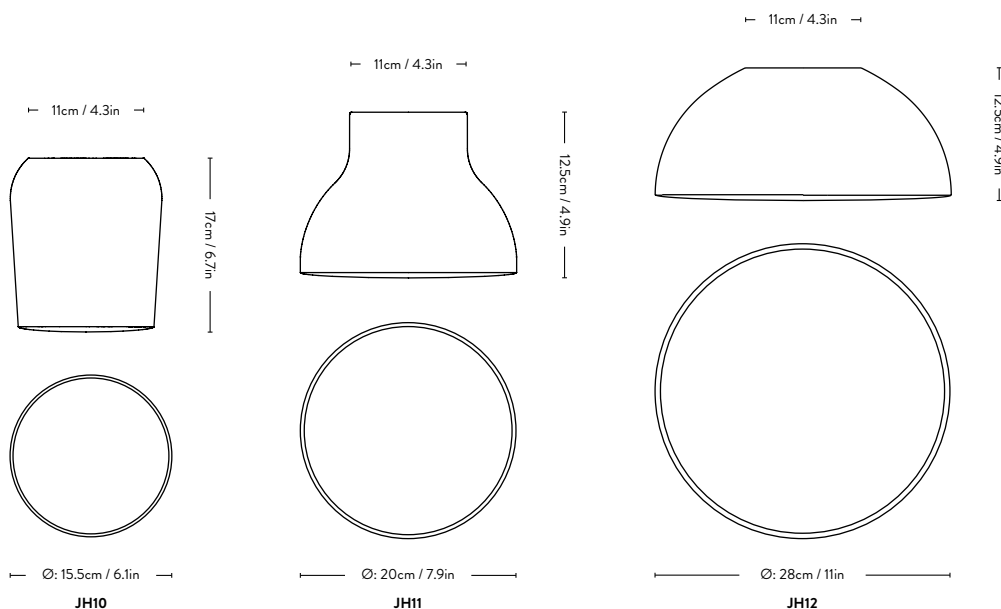

Tabata LN10

Luca Nichetto

2022

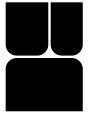

| Item no. | Product | Variant | Colli qty. | Lead time | Weight | PRICE EX. VAT (EUR) |
|----------|---------|---------------|------------|------------|--------|---------------------|
| 86002094 | Tabata | Black | 2 pcs | Stock item | 1.6 kg | 249 |
| 86002002 | Tabata | Silk Grey | 2 pcs | Stock item | 1.6 kg | 249 |
| 86002044 | Tabata | Dark Burgundy | 2 pcs | Stock item | 1.6 kg | 249 |

Technical Specification

Light source: G10, MAX 5 Watt (only LED)

Material: Powder coated aluminium & frosted acrylic

Bulb is not included.

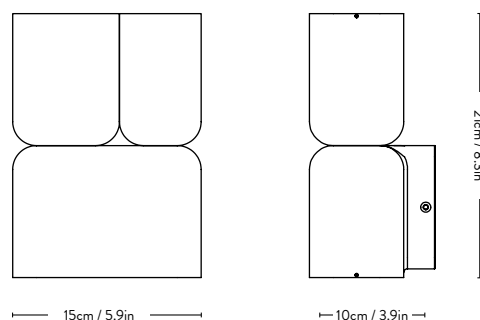

LN10

Colette ^{ATD6} &Tradition 2022



| Item no. | Product | Variant | Cord | Colli qty. | Lead time | Weight | PRICE EX. VAT (EUR) |
|----------|---------|----------------|--------------------------------------|------------|------------|---------|---------------------|
| 83600000 | Colette | White & Black | Black textile w dimmer. Length 250cm | 1 pc | Stock item | 1.60 kg | 283 |
| 83600001 | Colette | White & Merlot | Black textile w dimmer. Length 250cm | 1 pc | Stock item | 1.60 kg | 283 |

Technical Specification

E14 MAX 40 Watt

Material: Polyester, aluminium, iron

Dimmer is included.

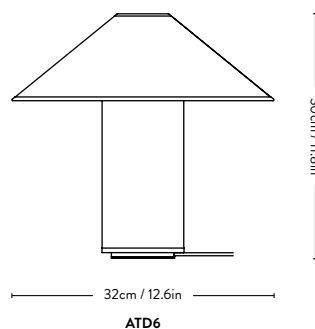

Formakami JH3-JH5 & JH18

Jaime Hayon

2015 & 2018

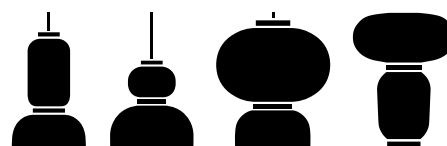

| Item no. | Product | Product code | Variant | Cord | Colli qty. | Lead time | Weight | PRICE EX. VAT (EUR) |
|----------|-----------|--------------|-------------|----------------------------|------------|------------|---------|---------------------|
| 83301130 | Formakami | JH3 | Ivory White | 4m Black textile | 2 pcs | Stock item | 0.80 kg | 170 |
| 83301230 | Formakami | JH4 | Ivory White | 4m Black textile | 2 pcs | Stock item | 0.70 kg | 170 |
| 83301330 | Formakami | JH5 | Ivory White | 4m Black textile | 2 pcs | Stock item | 1.50 kg | 192 |
| 83301430 | Formakami | JH18 | Ivory White | 2m Black textile w. dimmer | 2 pcs | Stock item | 1.00 kg | 192 |

Technical Specification

E27 Max 2 x 60 Watt

Material: Ivory White paper, Black stained oak.

Bulb is not included.
Black canopy included for pendants.

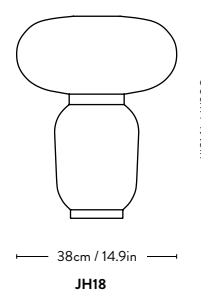
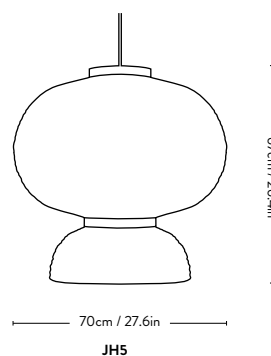
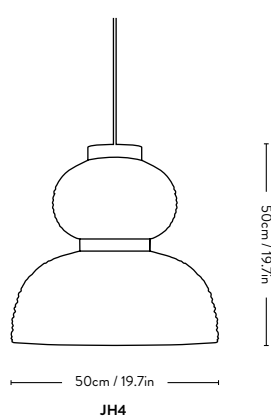
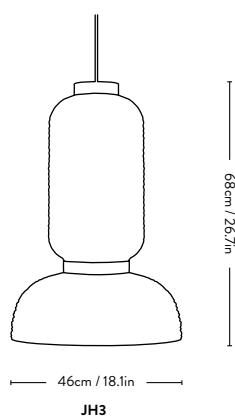

Setago ^{JH27} Jaime Hayon 2019



| Item no. | Product | Variant | Colli qty. | Lead time | Weight | PRICE EX. VAT (EUR) |
|----------|--|-----------------|------------|------------|---------|---------------------|
| 83502701 | Setago | Twilight & Sand | 2 pcs | Stock item | 0.69 kg | 113 |
| 83502702 | Setago | Nude & Forest | 2 pcs | Stock item | 0.69 kg | 113 |
| 83502703 | Setago | Rust & Thunder | 2 pcs | Stock item | 0.69 kg | 113 |
| 83502704 | Setago | Maroon & Grape | 2 pcs | Stock item | 0.69 kg | 113 |
| 83502010 | Multi charging station for 24 portable lamps | | 1 pc | Stock item | 1.5 kg | 125 |

Technical Specification

G4 Max 3 Watt LED bulb, dimmable
 CRI: > 80
 Colour temperature (Kelvin): 2800K
 Light output: 181 lumen
 Charging time: 8 hours
 Operating time in highest light setting: 10 hours
 Dimmability: 3 level touch dimmer on base 100% - 70% - 40 %
 Battery: Replaceable (spare part)
 IP class: IP44 (This lamp is for indoors use only. It can be taken outdoors, but must be kept and stored indoors.)

Material: Moulded polycarbonate.

LED bulb included - replaceable (spare part).
 Micro USB charging cable 150cm / 59in included.

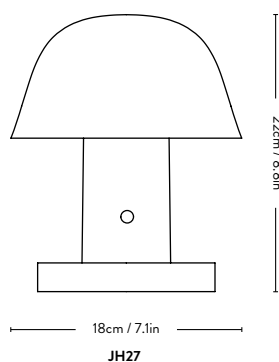

Bellevue ^{AJ7} Arne Jacobsen 1929

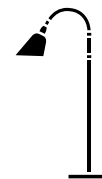

| Item no. | Product | Variant | Cord | Colli qty. | Lead time | Weight | PRICE EX. VAT (EUR) |
|----------|----------|----------------------------|----------------------------|------------|------------|---------|---------------------|
| 20811194 | Bellevue | Black & Brass | 2m Black textile w. switch | 1 pc | Stock item | 7.70 kg | 590 |
| 20811692 | Bellevue | White & Bronzed Brass | 2m White textile w. switch | 1 pc | Stock item | 7.70 kg | 590 |
| 20811690 | Bellevue | Stone Grey & Bronzed Brass | 2m Black textile w. switch | 1 pc | Stock item | 7.70 kg | 590 |

Technical Specification

E27 Max 25 Watt

Material: Lacquered brass, steel or aluminium.

Bulb is not included.

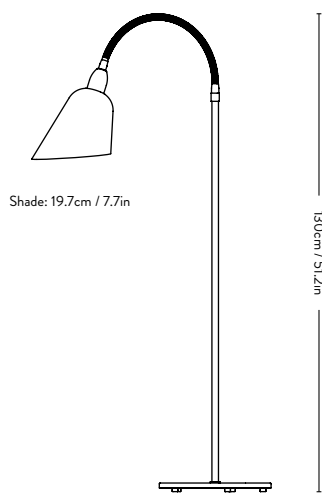

Base: Ø: 27.3cm / 10.7in

AJ7

Bellevue ^{AJ9} Arne Jacobsen 1929



| Item no. | Product | Variant | Cord | Colli qty. | Lead time | Weight | PRICE EX. VAT (EUR) |
|----------|---------------|---------------|------------------|------------|------------|---------|---------------------|
| 20811394 | Bellevue Wall | Black & Brass | 2m Black textile | 1 pc | Stock item | 1.40 kg | 272 |

Technical Specification

E14 Max 25 Watt

Material: Lacquered brass, steel or aluminium

Bellevue AJ9 is available as a plug-in (using the existing power cord) or hardwired (installed directly to the power outlet).

Bulb is not included.

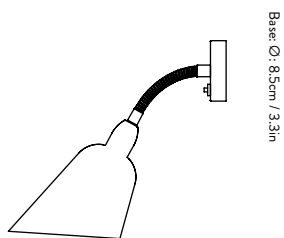

Shade: 16.7cm / 6.6in

Base Ø: 8.5cm / 3.3in

Bellevue ^{AJ11} Arne Jacobsen 1929

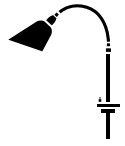

| Item no. | Product | Variant | Cord | Colli qty. | Lead time | Weight | PRICE EX. VAT (EUR) |
|----------|----------------------------|-------------|--------------|------------|------------|---------|---------------------|
| 20811594 | Bellevue Plug-in w. switch | Black/Brass | 2m Black pvc | 1 pc | Stock item | 1.10 kg | 351 |

Technical Specification

E14 Max 25 Watt

Material: Lacquered brass, steel or aluminium.

Suitable for table tops of min. 2 cm and max. 4 cm thickness.

Bulb is not included.

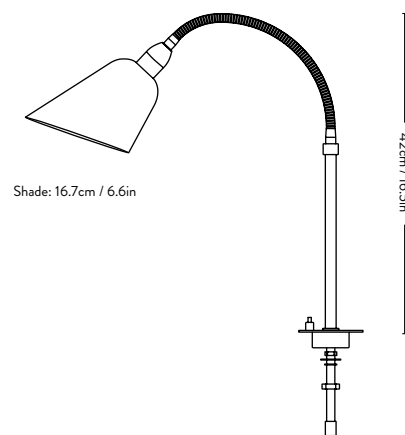

Base: Ø: 9.5cm / 3.8in

AJ11

NEW

Flowerpot^{VP10} Verner Panton 1968



| Item no. | Product | Variant | Cord | Colli qty. | Lead time | Weight | PRICE EX. VAT (EUR) |
|----------|-----------|---------------------|--------------------------|------------|------------|---------|---------------------|
| 20833101 | Flowerpot | Matt White | 3m White textile | 2 pcs | Stock item | 0.55 kg | 170 |
| 20839102 | Flowerpot | Matt Light Grey | 3m Grey textile | 2 pcs | Stock item | 0.55 kg | 170 |
| 20839501 | Flowerpot | Matt Black | 3m Black textile | 2 pcs | Stock item | 0.55 kg | 170 |
| 20832201 | Flowerpot | Mustard | 3m Mustard textile | 2 pcs | Stock item | 0.55 kg | 170 |
| 20835401 | Flowerpot | Stone Blue | 3m Stone blue textile | 2 pcs | Stock item | 0.55 kg | 170 |
| 20838901 | Flowerpot | Grey Beige | 3m Grey beige textile | 2 pcs | Stock item | 0.55 kg | 170 |
| 20839201 | Flowerpot | Signal Green | 3m Signal green textile | 2 pcs | Stock item | 0.55 kg | 170 |
| 20835002 | Flowerpot | Cobalt Blue | 3m Cobalt blue textile | 2 pcs | Stock item | 0.55 kg | 170 |
| 20833401 | Flowerpot | Vermilion Red | 3m Vermilion red textile | 2 pcs | Stock item | 0.55 kg | 170 |
| 20833501 | Flowerpot | Tangy Pink | 3m Tangy pink textile | 2 pcs | Stock item | 0.55 kg | 170 |
| 20833601 | Flowerpot | Dark Plum | 3m Dark plum textile | 2 pcs | Stock item | 0.55 kg | 170 |
| 20833701 | Flowerpot | Swim Blue | 3m Swim blue textile | 2 pcs | Stock item | 0.55 kg | 170 |
| 20839901 | Flowerpot | Chrome-plated | 3m Black textile | 2 pcs | Stock item | 0.55 kg | 238 |
| 20839601 | Flowerpot | Brass-plated | 3m Black textile | 2 pcs | Stock item | 0.55 kg | 238 |
| 20838101 | Flowerpot | Pattern Black/white | 3m Black textile | 2 pcs | Stock item | 0.55 kg | 238 |

Technical Specification

G9 Max. 5W LED

Material: Lacquered steel or plated steel.

Black textile cord: black canopy
White and other colored textile cords: White canopy

Bulb is not included.
Canopy included.

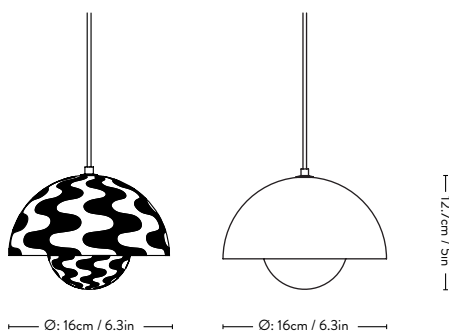

NEW

Flowerpot Chandelier^{VP10} Verner Panton 1968

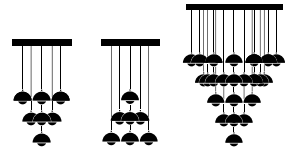

| Item no. | Product | Variant | Colli qty. | Lead time | Weight excl. lamps | PRICE EX. VAT (EUR) |
|----------|---------------------------------|--|------------|------------|-----------------------|------------------------|
| 20839910 | Chandelier VP10, 10 pendants | Matt white, Matt light grey, Matt black, Mustard, Stone blue, Grey beige, Signal green, Cobalt blue, Vermilion red, Tanga pink, Dark plum, Swim blue | 1 pc | Stock item | 3.0 kg | 2.039 |
| 20839911 | Chandelier VP10, 10 pendants | Brass-plated, Chrome-plated | 1 pc | Stock item | 3.0 kg | 2.720 |
| 20839912 | Chandelier VP10, 10 pendants | Pattern Black/White | 1 pc | Stock item | 3.0 kg | 2.720 |
| 20839913 | Chandelier VP10, 31 pendants | Matt white, Matt light grey, Matt black, Mustard, Stone blue, Grey beige, Signal green, Cobalt blue, Vermilion red, Tanga pink, Dark plum, Swim blue | 1 pc | 2 weeks | 8.0 kg | 5.831 |
| 20839914 | Chandelier VP10, 31 pendants | Brass-plated, Chrome-plated | 1 pc | 2 weeks | 8.0 kg | 7.944 |
| 20839915 | Chandelier VP10, 31 pendants | Pattern Black/White | 1 pc | 2 weeks | 8.0 kg | 7.944 |

Material: Lacquered aluminium with lacquered or plated steel pendants.

Canopy colour: White

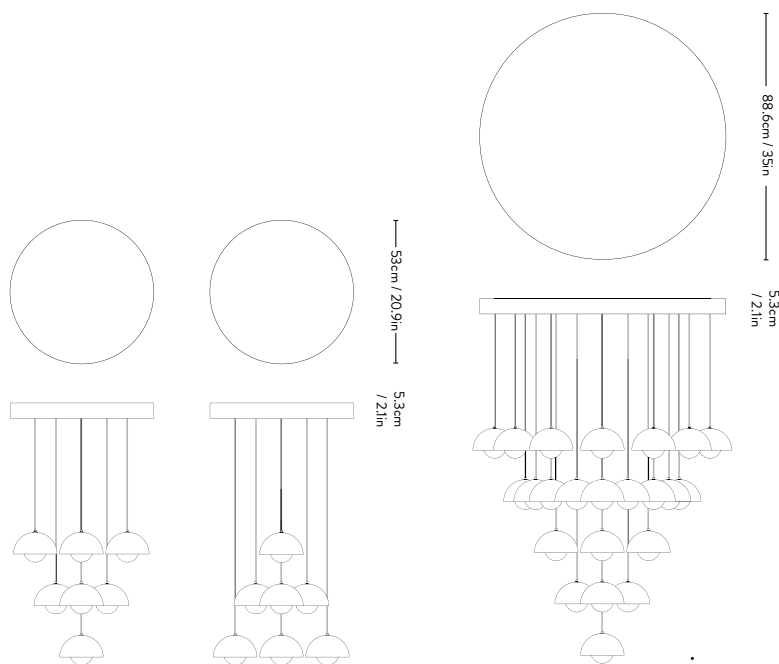

Chandelier VP10, 10 pendants

Chandelier VP10, 31 pendants

Flowerpot^{VP1} Verner Panton 1968



| Item no. | Product | Variant | Cord | Colli qty. | Lead time | Weight | PRICE EX. VAT (EUR) |
|----------|-----------|---------------------|--------------------------|------------|------------|---------|---------------------|
| 20703101 | Flowerpot | Matt White | 3m White textile | 2 pcs | Stock item | 0.95 kg | 204 |
| 20709102 | Flowerpot | Matt Light Grey | 3m Grey textile | 2 pcs | Stock item | 0.95 kg | 204 |
| 20709501 | Flowerpot | Matt Black | 3m Black textile | 2 pcs | Stock item | 0.95 kg | 204 |
| 20702201 | Flowerpot | Mustard | 3m Mustard textile | 2 pcs | Stock item | 0.95 kg | 204 |
| 20705401 | Flowerpot | Stone Blue | 3m Stone Blue textile | 2 pcs | Stock item | 0.95 kg | 204 |
| 20708901 | Flowerpot | Grey Beige | 3m Grey Beige textile | 2 pcs | Stock item | 0.95 kg | 204 |
| 20709201 | Flowerpot | Signal Green | 3m Signal Green textile | 2 pcs | Stock item | 0.95 kg | 204 |
| 20705002 | Flowerpot | Cobalt Blue | 3m Cobalt Blue textile | 2 pcs | Stock item | 0.95 kg | 204 |
| 20703401 | Flowerpot | Vermilion Red | 3m Vermilion Red Textile | 2 pcs | Stock item | 0.95 kg | 204 |
| 20703501 | Flowerpot | Tangy Pink | 3m Tangy Pink Textile | 2 pcs | Stock item | 0.95 kg | 204 |
| 20703601 | Flowerpot | Dark Plum | 3m Dark Plum Textile | 2 pcs | Stock item | 0.95 kg | 204 |
| 20703701 | Flowerpot | Swim Blue | 3m Swim Blue Textile | 2 pcs | Stock item | 0.95 kg | 204 |
| 20709801 | Flowerpot | Chrome-plated | 3m Black Textile | 2 pcs | Stock item | 0.95 kg | 283 |
| 20708701 | Flowerpot | Brass-plated | 3m Black Textile | 2 pcs | Stock item | 0.95 kg | 283 |
| 20708101 | Flowerpot | Pattern Black/White | 3m Black Textile | 2 pcs | Stock item | 0.95 kg | 283 |

Technical Specification

E27 Max 40 Watt

Material: Lacquered or plated steel.

Black textile cord: black canopy
White and other colored textile cords: White canopy

Bulb is not included.
Canopy included.

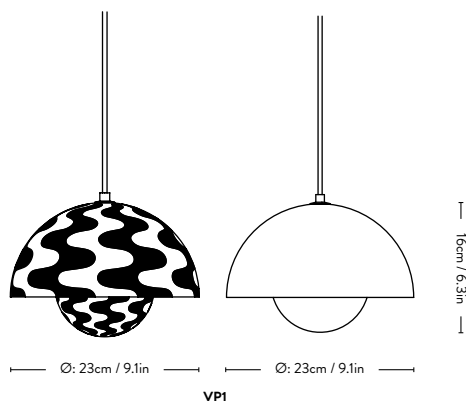

NEW

Flowerpot Chandelier^{VP1} Verner Panton 1968

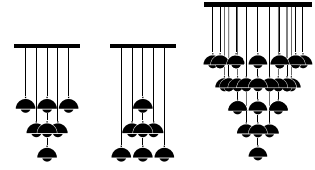

| Item no. | Product | Variant | Colli qty. | Lead time | Weight excl. lamps | PRICE EX. VAT (EUR) |
|----------|-----------------------------|--|------------|------------|--------------------|---------------------|
| 20709910 | Chandelier VP1, 10 pendants | Matt white, Matt light grey, Matt black, Mustard, Stone blue, Grey beige, Signal green, Cobalt blue, Vermilion red, Tangy pink, Dark plum, Swim blue | 1 pc | Stock item | 6.40 kg | 2.493 |
| 20709911 | Chandelier VP1, 10 pendants | Brass-plated, Chrome-plated | 1 pc | Stock item | 6.40 kg | 3.288 |
| 20709912 | Chandelier VP1, 10 pendants | Pattern Black/White | 1 pc | Stock item | 6.40 kg | 3.288 |
| 20709913 | Chandelier VP1, 31 pendants | Matt white, Matt light grey, Matt black, Mustard, Stone blue, Grey beige, Signal green, Cobalt blue, Vermilion red, Tangy pink, Dark plum, Swim blue | 1 pc | 2 weeks | 13.90 kg | 7.035 |
| 20709914 | Chandelier VP1, 31 pendants | Brass-plated, Chrome-plated | 1 pc | 2 weeks | 13.90 kg | 9.466 |
| 20709915 | Chandelier VP1, 31 pendants | Pattern Black/White | 1 pc | 2 weeks | 13.90 kg | 9.466 |

Material: Lacquered aluminium with lacquered or plated steel pendants.

Canopy colour: White

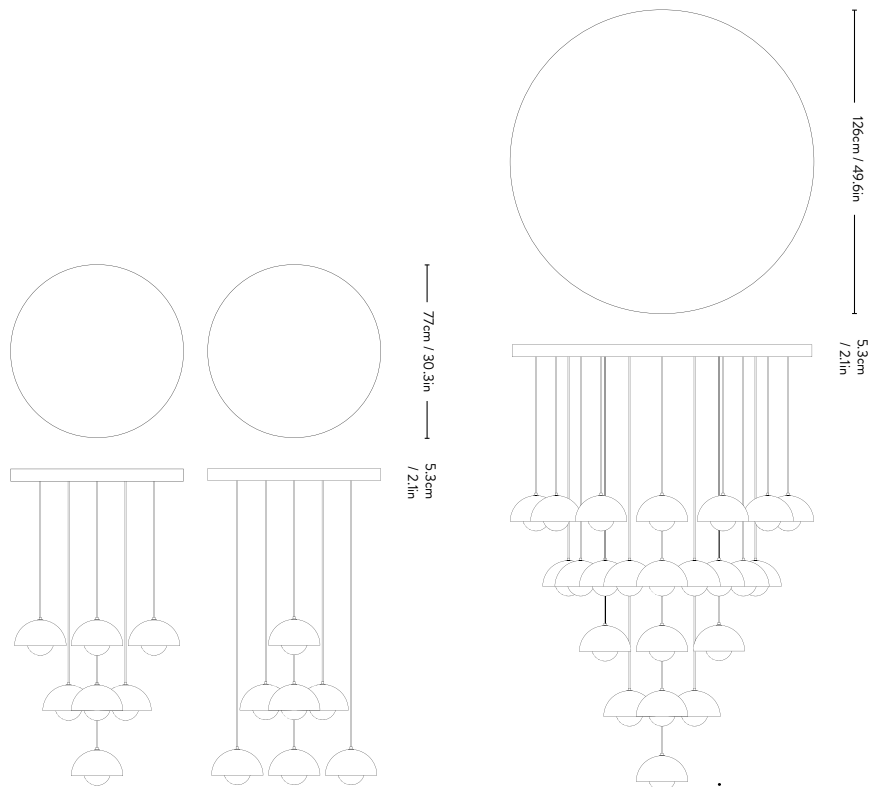

Chandelier VP1, 10 pendants

Chandelier VP1, 31 pendants

Flowerpot^{VP7} Verner Panton 1968



| Item no. | Product | Variant | Cord | Colli qty. | Lead time | Weight | PRICE EX. VAT (EUR) |
|----------|-----------|---------------------|--------------------------|------------|------------|---------|---------------------|
| 20773101 | Flowerpot | Matt White | 3m White textile | 1 pc | Stock item | 2.40 kg | 329 |
| 20779101 | Flowerpot | Matt Light Grey | 3m Grey textile | 1 pc | Stock item | 2.40 kg | 329 |
| 20779501 | Flowerpot | Matt Black | 3m Black textile | 1 pc | Stock item | 2.40 kg | 329 |
| 20772201 | Flowerpot | Mustard | 3m Mustard textile | 1 pc | Stock item | 2.40 kg | 329 |
| 20775401 | Flowerpot | Stone Blue | 3m Stone Blue textile | 1 pc | Stock item | 2.40 kg | 329 |
| 20778901 | Flowerpot | Grey Beige | 3m Grey Beige textile | 1 pc | Stock item | 2.40 kg | 329 |
| 20779201 | Flowerpot | Signal Green | 3m Signal Green textile | 1 pc | Stock item | 2.40 kg | 329 |
| 20775002 | Flowerpot | Cobalt Blue | 3m Cobalt Blue Textile | 1 pc | Stock item | 2.40 kg | 329 |
| 20773401 | Flowerpot | Vermilion Red | 3m Vermilion Red Textile | 1 pc | Stock item | 2.40 kg | 329 |
| 20773501 | Flowerpot | Tangy Pink | 3m Tangy Pink Textile | 1 pc | Stock item | 2.40 kg | 329 |
| 20773601 | Flowerpot | Dark Plum | 3m Dark Plum Textile | 1 pc | Stock item | 2.40 kg | 329 |
| 20773701 | Flowerpot | Swim Blue | 3m Swim Blue Textile | 1 pc | Stock item | 2.40 kg | 329 |
| 20778101 | Flowerpot | Pattern Black/White | 3m Black Textile | 1 pc | Stock item | 2.40 kg | 510 |

Technical Specification

E27 Max 100 Watt

Material: Lacquered steel.

Black textile cord: black canopy
White and other colored textile cords: White canopy

Bulb is not included.
Canopy included.

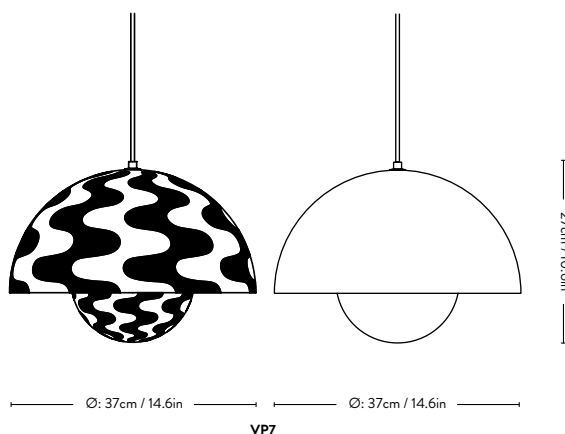

Flowerpot^{VP2} Verner Panton 1968



| Item no. | Product | Variant | Cord | Colli qty. | Lead time | Weight | PRICE EX. VAT (EUR) |
|----------|-----------|---------------------|--------------------------|------------|------------|---------|---------------------|
| 20763101 | Flowerpot | Matt White | 3m White textile | 1 pc | Stock item | 3.40 kg | 476 |
| 207695 | Flowerpot | Matt Black | 3m Black textile | 1 pc | Stock item | 3.40 kg | 476 |
| 20768901 | Flowerpot | Grey Beige | 3m Grey Beige textile | 1 pc | Stock item | 3.40 kg | 476 |
| 20765401 | Flowerpot | Stone Blue | 3m Stone Blue textile | 1 pc | Stock item | 3.40 kg | 476 |
| 20763401 | Flowerpot | Vermilion Red | 3m Vermilion Red Textile | 1 pc | Stock item | 3.40 kg | 476 |
| 20768101 | Flowerpot | Pattern Black/White | 3m Black Textile | 1 pc | Stock item | 3.40 kg | 635 |

Technical Specification

E27 Max 60 Watt

Material: Lacquered aluminium.

Black textile cord: black canopy
White and other colored textile cords: White canopy

Bulb is not included.
Canopy included.

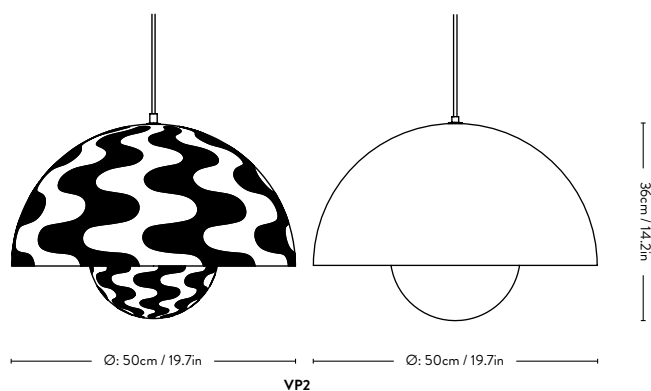

Flowerpot^{VP3} Verner Panton 1968



| Item no. | Product | Variant | Cord | Colli qty. | Lead time | Weight | PRICE EX. VAT (EUR) |
|----------|-----------|-----------------|------------------------|------------|------------|---------|---------------------|
| 20723101 | Flowerpot | Matt White | 2m clear pvc w. switch | 1 pc | Stock item | 4.50 kg | 261 |
| 20729101 | Flowerpot | Matt Light Grey | 2m clear pvc w. switch | 1 pc | Stock item | 4.50 kg | 261 |
| 20729501 | Flowerpot | Matt Black | 2m clear pvc w. switch | 1 pc | Stock item | 4.50 kg | 261 |
| 20722201 | Flowerpot | Mustard | 2m clear pvc w. switch | 1 pc | Stock item | 4.50 kg | 261 |
| 20725401 | Flowerpot | Stone Blue | 2m clear pvc w. switch | 1 pc | Stock item | 4.50 kg | 261 |
| 20728901 | Flowerpot | Grey Beige | 2m clear pvc w. switch | 1 pc | Stock item | 4.50 kg | 261 |
| 20729201 | Flowerpot | Signal Green | 2m clear pvc w. switch | 1 pc | Stock item | 4.50 kg | 261 |
| 20725002 | Flowerpot | Cobalt Blue | 2m clear pvc w. switch | 1 pc | Stock item | 4.50 kg | 261 |
| 20723401 | Flowerpot | Vermilion Red | 2m clear pvc w. switch | 1 pc | Stock item | 4.50 kg | 261 |
| 20723501 | Flowerpot | Tangy Pink | 2m clear pvc w. switch | 1 pc | Stock item | 4.50 kg | 261 |
| 20723601 | Flowerpot | Dark Plum | 2m clear pvc w. switch | 1 pc | Stock item | 4.50 kg | 261 |
| 20723701 | Flowerpot | Swim Blue | 2m clear pvc w. switch | 1 pc | Stock item | 4.50 kg | 261 |
| 20729801 | Flowerpot | Chrome-plated | 2m clear pvc w. switch | 1 pc | Stock item | 4.50 kg | 397 |
| 20728701 | Flowerpot | Brass-plated | 2m clear pvc w. switch | 1 pc | Stock item | 4.50 kg | 397 |

Technical Specification

E27 Max 40 Watt

Material: Lacquered or plated steel.

Bulb is not included.

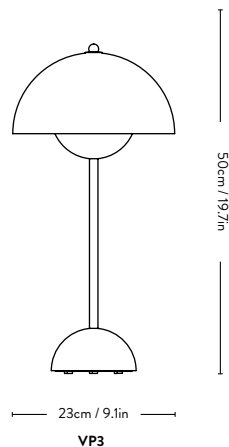

Flowerpot^{VP4} Verner Panton 1968

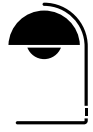

| Item no. | Product | Variant | Cord | Colli qty. | Lead time | Weight | PRICE EX. VAT (EUR) |
|----------|-----------|---------------|----------------------------|------------|------------|---------|---------------------|
| 20733101 | Flowerpot | Matt White | 2m White textile w. switch | 1 pc | Stock item | 1.23 kg | 261 |
| 20739501 | Flowerpot | Matt Black | 2m Black textile w. switch | 1 pc | Stock item | 1.23 kg | 261 |
| 20739801 | Flowerpot | Chrome-plated | 2m Black Textile w. switch | 1 pc | Stock item | 1.23 kg | 397 |

Technical Specification

E27 max 40 Watt

Material: Lacquered or plated steel.

Bulb is not included.

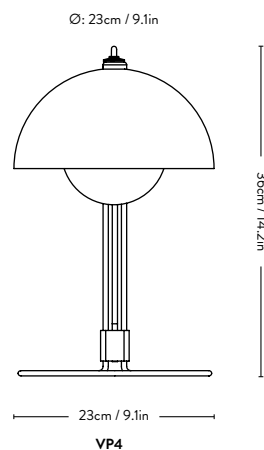

Flowerpot^{VP8} Verner Panton 1968



| Item no. | Product | Variant | Cord | Colli qty. | Lead time | Weight | PRICE EX. VAT (EUR) |
|----------|-----------|-----------------|--------------------------|------------|------------|--------|---------------------|
| 20793101 | Flowerpot | Matt White | 2m White textile | 1 pc | Stock item | 1.3 kg | 283 |
| 20799501 | Flowerpot | Matt Black | 2m Black textile | 1 pc | Stock item | 1.3 kg | 283 |
| 20799101 | Flowerpot | Matt Light Grey | 2m Grey textile | 1 pc | Stock item | 1.3 kg | 283 |
| 20792201 | Flowerpot | Mustard | 2m Mustard textile | 1 pc | Stock item | 1.3 kg | 283 |
| 20798901 | Flowerpot | Grey Beige | 2m Grey Beige textile | 1 pc | Stock item | 1.3 kg | 283 |
| 20793401 | Flowerpot | Vermilion Red | 2m Vermilion Red textile | 1 pc | Stock item | 1.3 kg | 283 |
| 20799201 | Flowerpot | Signal Green | 2m Signal Green textile | 1 pc | Stock item | 1.3 kg | 283 |
| 20799901 | Flowerpot | Chrome-plated | 2m Black Textile | 1 pc | Stock item | 1.3 kg | 420 |

Technical Specification

E27 MAX 40 Watt

Material: Lacquered or plated steel

Flowerpot VP8 is available as a plug-in (using the existing power cord) or hardwired (installed directly to the power outlet).

Bulb is not included.

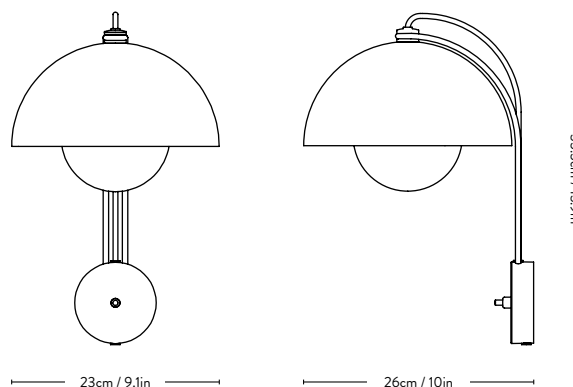

VP8

Flowerpot ^{VP9} Verner Panton 1968



| Item no. | Product | Variant | Colli qty. | Lead time | Weight | PRICE EX. VAT (EUR) |
|----------|---|-----------------|------------|------------|---------|---------------------|
| 20713101 | Flowerpot | Matt White | 2 pcs | Stock item | 0.83 kg | 158 |
| 20719102 | Flowerpot | Matt Light Grey | 2 pcs | Stock item | 0.83 kg | 158 |
| 20719501 | Flowerpot | Matt Black | 2 pcs | Stock item | 0.83 kg | 158 |
| 20712201 | Flowerpot | Mustard | 2 pcs | Stock item | 0.83 kg | 158 |
| 20718901 | Flowerpot | Grey Beige | 2 pcs | Stock item | 0.83 kg | 158 |
| 20715401 | Flowerpot | Stone Blue | 2 pcs | Stock item | 0.83 kg | 158 |
| 20719201 | Flowerpot | Signal Green | 2 pcs | Stock item | 0.83 kg | 158 |
| 20715002 | Flowerpot | Cobalt Blue | 2 pcs | Stock item | 0.83 kg | 158 |
| 20713401 | Flowerpot | Vermilion Red | 2 pcs | Stock item | 0.83 kg | 158 |
| 20713501 | Flowerpot | Tangy Pink | 2 pcs | Stock item | 0.83 kg | 158 |
| 20713601 | Flowerpot | Dark Plum | 2 pcs | Stock item | 0.83 kg | 158 |
| 20713701 | Flowerpot | Swim Blue | 2 pcs | Stock item | 0.83 kg | 158 |
| 20719601 | Flowerpot | Brass-Plated | 2 pcs | Stock item | 0.83 kg | 238 |
| 20719901 | Flowerpot | Chrome-Plated | 2 pcs | Stock item | 0.83 kg | 238 |
| 83502010 | Multi charging station for 24 portable lamps | | 1 pc | Stock item | 1.5 kg | 125 |
| 83502110 | Magnetic VP9 charging tray incl. Power supply *11 lamps | Black | 1 pc | Stock item | 5 kg | 567 |
| 83520002 | Trolley *fits 3 trays | | 1 pc | Stock item | 18 kg | 181 |

Technical Specification

3 Watt LED board, dimmable
 CRI: > 90
 Colour temperature (Kelvin): 2700K
 Light output: 104 lumen
 Charging time: 8 hours
 Operating time in highest light setting: 10 hours
 Dimmability: 3 level touch dimmer 100% - 50% - 20 %
 Battery: Replaceable (spare part)
 IP class: IP44
 (This lamp is for indoors use only. It can be taken outdoors, but must be kept and stored indoors.)

Material: Lacquered polycarbonat (PC) and steel

LED bulb included - replaceable (spare part).
 USB magnetic cable 200cm/78.7in, included.



W: 46cm / 18.1in, L: 102cm / 40.2in, H: 124cm / 47.2in

Trolley

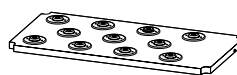

W: 44cm / 17.3in, L: 88cm / 34.6in, H: 2.8cm / 1.1in

Charging tray

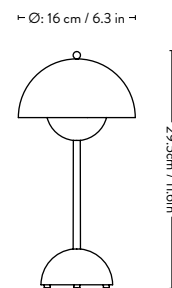

Ø: 9.6cm / 3.8in

VP9

Topan ^{VP6} Verner Panton 1959



| Item no. | Product | Variant | Cord | Colli qty. | Lead time | Weight | PRICE EX. VAT (EUR) |
|----------|---------|---------------|--------------------------|------------|------------|---------|---------------------|
| 207895 | Topan | Matt Black | 3m Black textile | 2 pcs | Stock item | 0.65 kg | 204 |
| 207834 | Topan | Vermilion Red | 3m Vermilion Red textile | 2 pcs | Stock item | 0.65 kg | 204 |
| 207880 | Topan | Grey Beige | 3m Grey Beige textile | 2 pcs | Stock item | 0.65 kg | 204 |
| 207898 | Topan | Chrome-plated | 3m Black textile | 2 pcs | Stock item | 0.65 kg | 283 |

Technical Specification

E27 Max 40 Watt

Material: Lacquered or plated aluminium.

Black textile cord: black canopy
White and other colored textile cords: White canopy

Bulb is not included.
Canopy included.

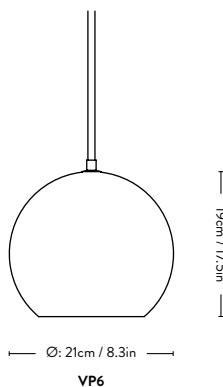

Utzon^{JU1} Jørn Utzon 1947



| Item no. | Product | Variant | Cord | Colli qty. | Lead time | Weight | PRICE EX. VAT (EUR) |
|----------|---------|--------------|------------------|------------|------------|---------|---------------------|
| 206030 | Utzon | Matt White | 4m White textile | 2 pcs | Stock item | 1.40 kg | 227 |
| 206091 | Utzon | Steel Blue | 4m Black textile | 2 pcs | Stock item | 1.40 kg | 249 |
| 206090 | Utzon | Brass-plated | 4m Black textile | 2 pcs | Stock item | 1.40 kg | 431 |

Technical Specification

E27 Max 60 Watt

Material: Lacquered or plated steel.

Black textile cord: black canopy
White textile cords: White canopy

Bulb is not included.
Canopy included.

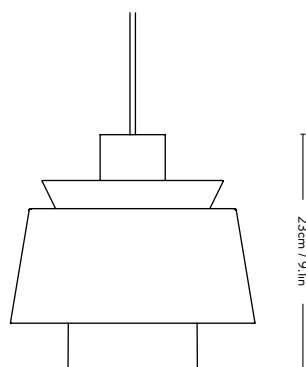

Ø: 22cm / 8.7in

JU1

Copenhagen SC6-SC8 Space Copenhagen 2014

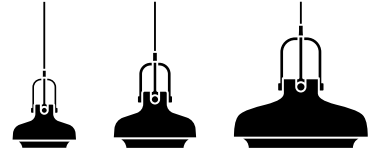

| Item no. | Product | Product code | Variant | Cord | Colli qty. | Lead time | Weight | PRICE EX. VAT (EUR) |
|----------|-----------------|--------------|------------|------------------|------------|------------|---------|---------------------|
| 20951195 | Copenhagen | SC6 | Matt Black | 4m Black textile | 2 pcs | Stock item | 0.83 kg | 181 |
| 20951120 | Copenhagen | SC6 | Opal Glass | 4m Black textile | 2 pcs | Stock item | 1.10 kg | 261 |
| 20951295 | Copenhagen | SC7 | Matt Black | 4m Black textile | 1 pc | Stock item | 2.08 kg | 329 |
| 20951220 | Copenhagen | SC7 | Opal Glass | 4m Black textile | 1 pc | Stock item | 3.00 kg | 408 |
| 20951395 | Copenhagen | SC8 | Matt Black | 6m Black textile | 1 pc | Stock item | 4.50 kg | 681 |
| 20951100 | Acrylic difuser | SC6 | | | 1 pc | Stock item | 0.04 kg | 9 |
| 20951200 | Acrylic difuser | SC7 | | | 1 pc | Stock item | 0.14 kg | 11 |
| 20951300 | Acrylic difuser | SC8 | | | 1 pc | Stock item | 0.44 kg | 16 |

Technical Specification

SC6: G9 MAX 5 watt LED
 SC7: E27 MAX 100 Watt
 SC8: E27 MAX 150 Watt

Material: Lacquered steel shade with lacquered bronzed brass bracket
 Satinized opal glass with bronzed brass bracket.

Light bulb is not included.
 Black canopy included.

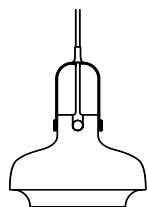

Ø: 20cm / 7.8in

SC6

25cm / 9.8in

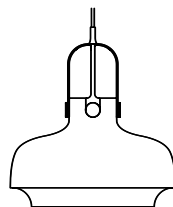

Ø: 35cm / 13.8in

SC7

40cm / 15.7in

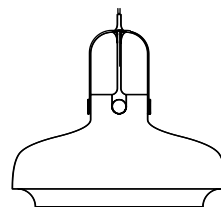

Ø: 60cm / 23.6in

SC8

53cm / 20.7in

Copenhagen SC13 & SC14

Space Copenhagen 2018

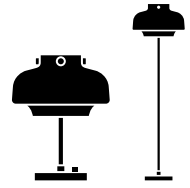

| Item no. | Product | Product code | Variant | Cord | Colli qty. | Lead time | Weight | PRICE EX. VAT (EUR) |
|----------|------------------|--------------|----------------------------|--------------------------|------------|------------|----------|---------------------|
| 65201001 | Copenhagen Table | SC13 | Opal Glass & Bronzed Brass | 3.5m Black pvc | 1 pc | Stock item | 4.40 kg | 545 |
| 65211001 | Copenhagen Floor | SC14 | Opal Glass & Bronzed Brass | 3.5m Black pvc w. switch | 1 pc | Stock item | 11.00 kg | 999 |

Technical Specification

SC13

6.6 Watt LED board, dimmable

CRI: > 85

Colour temperature (Kelvin): 2200K-2800K

Light output: 700 lumen

This product contains a light source of energy efficiency class G. LED board included – not replaceable.

SC14

16.3 Watt LED board, dimmable

CRI: > 85

Colour temperature (Kelvin): 2200K-2800K

Light output: 1300 lumen

This product contains a light source of energy efficiency class G. LED board included – not replaceable.

Material: Satinized opal glass & lacquered bronzed brass.

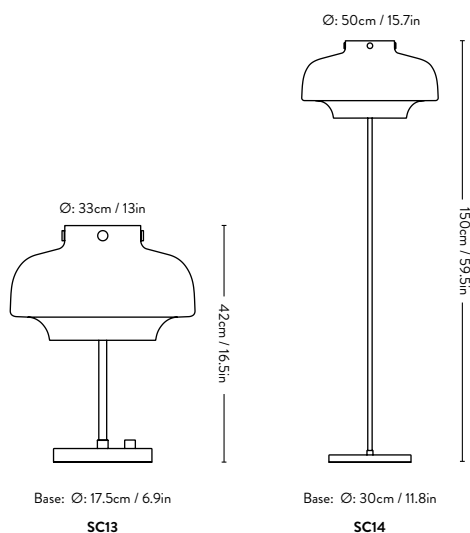

Spinning^{BH1 & BH2} Benjamin Hubert 2010



| Item no. | Product | Variant | Cord | Colli qty. | Lead time | Weight | PRICE EX. VAT (EUR) |
|----------|----------|------------|--------------|------------|------------|---------|---------------------|
| 20929003 | Spinning | Matt Black | 4m Black pvc | 1 pc | Stock item | 1.27 kg | 204 |
| 20919003 | Spinning | Matt Black | 4m Black pvc | 1 pc | Stock item | 2.30 kg | 283 |

Technical Specification

BH1: E27 Max 60 Watt
BH2: E27 Max 60 Watt

Material: Lacquered aluminium.

Bulb is not included.
Black canopy included.

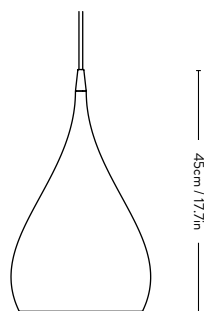

Ø: 25cm / 9.8in

BH1

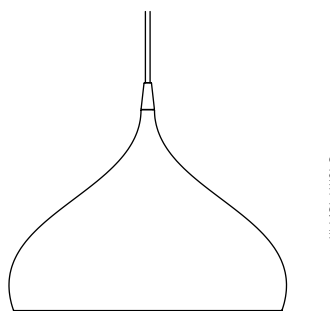

Ø: 40cm / 15.7in

BH2

Mega Bulb ^{SR2} Sofie Refer 2006



| Item no. | Product | Variant | Cord | Colli qty. | Lead time | Weight | PRICE EX. VAT (EUR) |
|----------|-----------|---------|------------------|------------|------------|--------|---------------------|
| 200400 | Mega Bulb | Clear | 3m Clear pvc | 2 pcs | Stock item | 0.9 kg | 158 |
| 200594 | Mega Bulb | Silver | 3m Black textile | 2 pcs | Stock item | 0.9 kg | 158 |
| 200630 | Mega Bulb | Gold | 3m White textile | 2 pcs | Stock item | 0.9 kg | 158 |

Technical Specification

E27 Max 60 Watt

Material: Mouth blown glass, porcelain lamp holder.

Bulb is not included.
Canopy included.

Black textile cord: black canopy
White and clear textile cords: White canopy

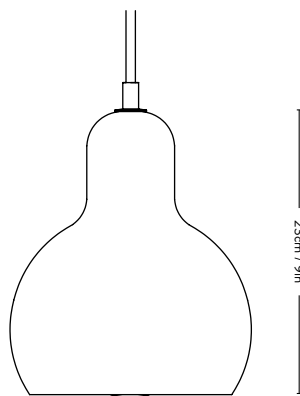

SR2

Journey SHY1 & SHY2

Signe Hytte

2018



| Item no. | Product | Product code | Variant | Cord | Colli qty. | Lead time | Weight | PRICE EX. VAT (EUR) |
|----------|---------|--------------|-----------|--------------|------------|------------|---------|---------------------|
| 20321094 | Journey | SHY1 | Black | 2m Black pvc | 2 pcs | Stock item | 1.60 kg | 283 |
| 20321002 | Journey | SHY1 | Silk Grey | 2m Black pvc | 2 pcs | Stock item | 1.60 kg | 283 |
| 20322094 | Journey | SHY2 | Black | Hardwired | 2 pcs | Stock item | 1.30 kg | 238 |
| 20322002 | Journey | SHY2 | Silk Grey | Hardwired | 2 pcs | Stock item | 1.30 kg | 238 |

Technical Specification

SHY1: 4.8 Watt LED board, dimmable
 CRI: > 85
 Colour temperature (Kelvin): 2200-2800K
 Light output: 480 lumen
 Dimmability: Dimmer on base, dim-to-warm technology
 IP class: IP20

SHY2: G9 Max 5 Watt LED

Material: Mouth blown glass, steel.

SHY1: This product contains a light source of energy efficiency class G. LED board included - not replaceable.

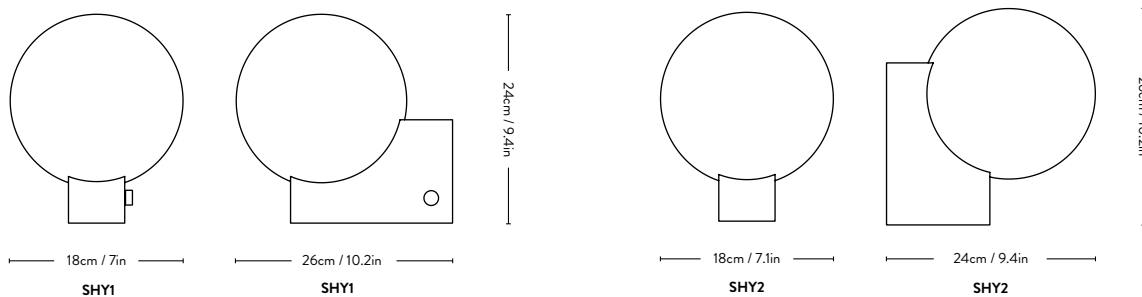

Herman ^{SHY3} Signe Hytte 2022

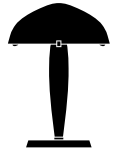

| Item no. | Product | Variant | Cord | Colli qty. | Lead time | Weight | PRICE EX. VAT (EUR) |
|----------|---------|-------------------------------------|-------------------------|------------|------------|---------|---------------------|
| 20820000 | Herman | Opal glass w. Walnut & Cream Marble | Black textile w. dimmer | 2 pcs | Stock item | 2.10 kg | 340 |

Technical Specification

SHY3: E14 Max 25W

Material: Opal glass shade, walnut stem, beige marble, chrome details, textile cord.

Dimmer is included.
Light bulb is not included

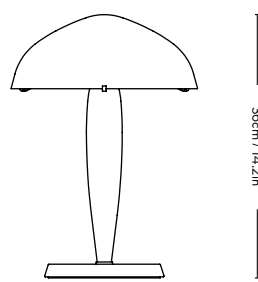

25cm / 9.8in

SHY3

NEW

Montera JH42

Jaime Hayon

2024

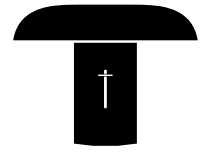

| Item no. | Product | Variant | Cord | Colli qty. | Lead time | Weight | PRICE EX. VAT (EUR) |
|----------|--------------------|------------|----------|------------|------------|---------|---------------------|
| 25050172 | Montera Table lamp | Forest/Sky | 2m black | 1 pc | Stock item | 2.80 kg | 454 |
| 25050174 | Montera Table lamp | Amber/Ruby | 2m black | 1 pc | Stock item | 2.80 kg | 454 |

Technical Specification

JH42: 220-240V - 50Hz, 2xE14 max 40W

Material: Painted aluminium, brass dimmer

Light bulb is not included

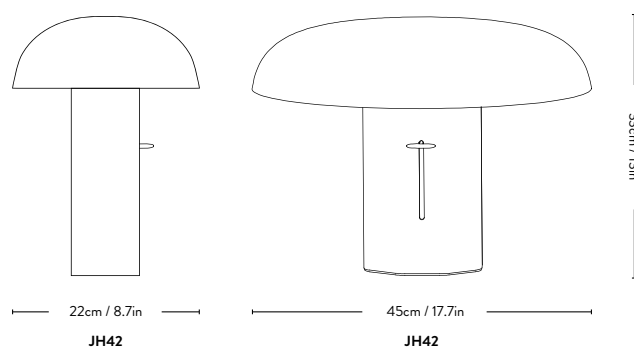

Tripod ^{HM8 & HM9} Hvidt & Mølgaard 1953

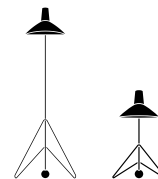

| Item no. | Product | Product code | Variant | Cord | Colli qty. | Lead time | Weight | PRICE EX. VAT (EUR) |
|----------|-------------------|--------------|---------|----------------------------|------------|------------|---------|---------------------|
| 14080094 | Tripod Floor lamp | HM8 | Black | 2m Black textile w. switch | 1 pc | Stock item | 5.30 kg | 681 |
| 14090094 | Tripod Table lamp | HM9 | Black | 2m Black textile w. switch | 1 pc | Stock item | 0.90 kg | 295 |

Technical Specification

HM8: E27 Max 60 Watt

HM9: E14 Max 25 Watt

Material: Lacquered metal shade and base, lacquered brass.

Bulb is not included.

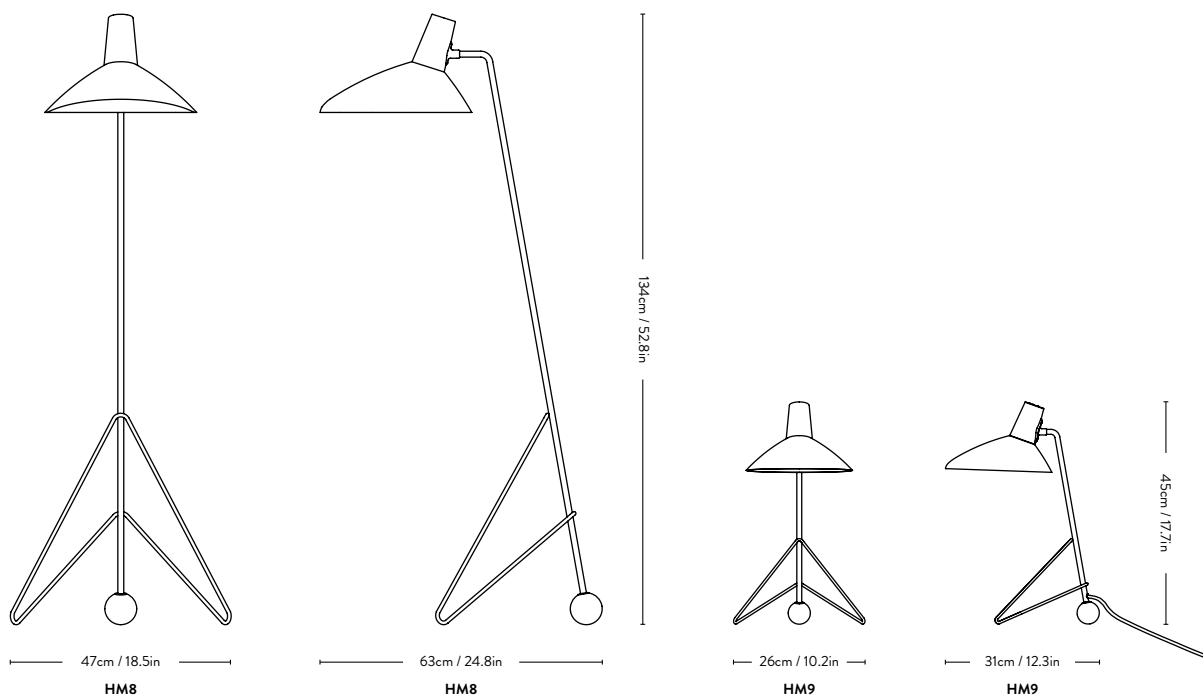

Mist AP15-AP17

All the Way to Paris 2023

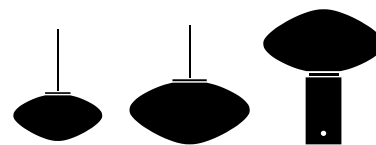

| Item no. | Product | Product code | Variant | Cord | Colli qty. | Lead time | Weight | PRICE EX. VAT (EUR) |
|----------|---------|--------------|-------------------------------|--------------------|------------|------------|--------|---------------------|
| 20991900 | Mist | AP15 | Opal Glass | 3m white textile | 1 pc | Stock item | 1.3 kg | 283 |
| 20991901 | Mist | AP16 | Opal Glass | 3m white textile | 1 pc | Stock item | 2.0 kg | 431 |
| 20991902 | Mist | AP17 | Guatemala Verde w. Opal glass | 2.5m black textile | 1 pc | Stock item | 6.2 kg | 545 |

Technical Specification

AP15: G9 Max. 20 watt
 AP16: E14 Max 40 watt
 AP17: E14 Max. 40 watt

Material: Mouth blown glass, stone base and details in metal.

Bulb is not included.
 White canopy is included for pendants.

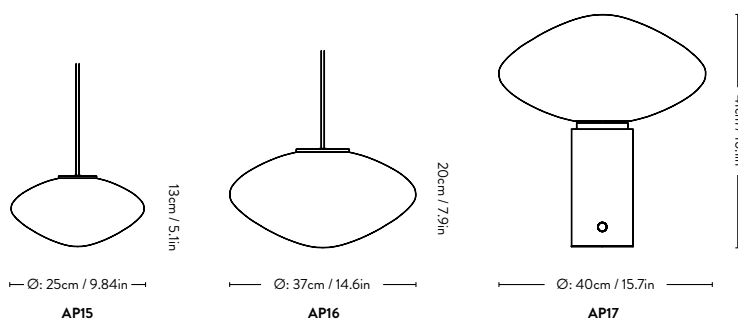

Lucca^{SC51} Space Copenhagen 2020



| Item no. | Product | Variant | Colli qty. | Lead time | Weight | PRICE EX. VAT (EUR) |
|----------|--|---------------------|------------|------------|---------|---------------------|
| 83482001 | Lucca | Opal glass & Moss | 2 pcs | Stock item | 0.90 kg | 136 |
| 83482041 | Lucca | Opal glass & Maroon | 2 pcs | Stock item | 0.90 kg | 136 |
| 83482000 | Lucca | Opal glass & Black | 2 pcs | Stock item | 0.90 kg | 136 |
| 83502010 | Multi charging station for 24 portable lamps | | 1 pc | Stock item | 1.5 kg | 125 |

Technical Specification

2.5 Watt LED Board, dimmable
 CRI: > 90
 Colour temperature (Kelvin): 2700K
 Light output: 143 lumen
 Charging time: 8 hours
 Operating time in highest light setting: 12 hours
 Dimmability: 3 level touch dimmer on base 100% - 50% - 20 %
 IP class: IP44 (This lamp is for indoors use only. It can be taken outdoors but must be kept and stored indoors)

Material: Satinized opal glass, powder coated metal, brass.
 LED bulb included.

Micro USB charging cable 200cm/78.7in, included.

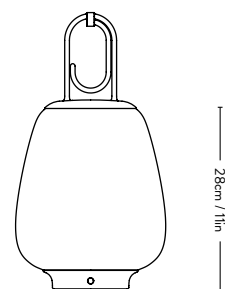

16cm / 6.30in
 SC51

Manhattan SC52 Space Copenhagen 2020

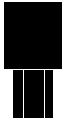

| Item no. | Product | Variant | Colli qty. | Lead time | Weight | PRICE EX. VAT (EUR) |
|----------|--|---------|------------|------------|--------|---------------------|
| 83529529 | Manhattan | Bronzed | 2 pcs | Stock item | 0.4 kg | 170 |
| 83502010 | Multi charging station for 24 portable lamps | | 1 pc | Stock item | 1.5 kg | 125 |
| 83520002 | Trolley *fits 3 trays | Black | 1 pc | Stock item | 18 kg | 181 |
| 83501010 | Charging tray incl. power supply *12 lamps | Black | 1 pc | Stock item | | 545 |

Technical Specification

G4 1 Watt LED bulb, dimmable
 CRI: > 85
 Colour temperature (Kelvin): 2700K
 Light output: 100 lumen
 Charging time: 1 battery 3.5 hours – 2 batteries 6 hours
 Operating time in highest light setting:
 1 battery 11 hours – 2 batteries 20 hours
 Dimmability: 3 level touch dimmer on base 100% - 70% - 40%
 Battery: Delivery with 1 battery. Replaceable (spare part)
 IP class: IP20

Material: Aluminium, Canvas, ABS

LED bulb included – replaceable (spare part).
 USB magnetic cable 200 cm/78.7in

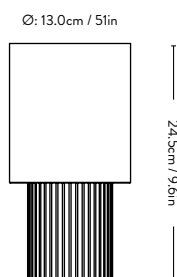

Ø: 13.0cm / 5.1in

24.5cm / 9.6in

Base Ø: 8.4cm / 3.3in

SC52

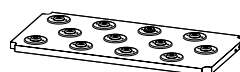

W: 43.8cm / 17.2in, L: 89cm / 35in, H: 2.8cm / 1.1in

Charging tray



W: 46cm / 18.1in, L: 102cm / 40.2in, H: 124cm / 47.2in

Trolley

Como ^{SC53} Space Copenhagen 2020



| Item no. | Product | Variant | Colli qty. | Lead time | Weight | PRICE EX. VAT (EUR) |
|----------|--|----------------------|------------|------------|--------|---------------------|
| 83512095 | Como | Bronzed | 2 pcs | Stock item | 0.4 kg | 170 |
| 83512094 | Como | Black | 2 pcs | Stock item | 0.4 kg | 170 |
| 83512096 | Como | Brass | 2 pcs | Stock item | 0.4 kg | 227 |
| 83512003 | Como | Stone Blue | 2 pcs | Stock item | 0.4 kg | 170 |
| 83512002 | Como | Red Brown | 2 pcs | Stock item | 0.4 kg | 170 |
| 83512097 | Como | Aluminium NEW | 2 pcs | Stock item | 0.4 kg | 170 |
| 83502010 | Multi charging station for 24 portable lamps | | 1 pc | Stock item | 1.5 kg | 125 |
| 83520002 | Trolley *fits 3 trays | Black | 1 pc | Stock item | 18 kg | 181 |
| 83501010 | Charging tray incl. power supply *12 lamps | Black | 1 pc | Stock item | | 545 |

Technical Specification

G4 1 Watt LED bulb, dimmable
 CRI: > 85
 Colour temperature (Kelvin): 2700K
 Light output: 100 lumen
 Charging time: 1 battery 3.5 hours – 2 batteries 6 hours
 Operating time in highest light setting:
 1 battery 11 hours – 2 batteries 20 hours
 Dimmability: 3 level touch dimmer on base 100% - 70% - 40%
 Battery: Delivery with 1 battery. Replaceable (spare part)
 IP class: IP44 (This lamp is for indoors use only. It can be taken outdoors, but must be kept and stored indoors.)

Material: Anodized or lacqured aluminium or or lacqured brass, ABS

LED bulb included – replaceable (spare part).
 USB magnetic cable 200 cm/78.7in

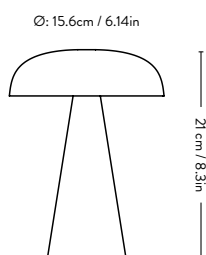

SC53

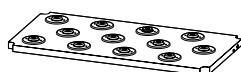

W: 43.8cm / 17.2in, L: 89cm / 35in, H: 2.8cm / 1.1in

Charging tray



W: 46cm / 18.1in, L: 102cm / 40.2in, H: 124cm / 47.2in

Trolley

Caret^{MF1} Matteo Fogale 2022

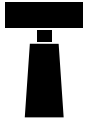

| Item no. | Product | Variant | Colli qty. | Lead time | Weight | PRICE EX. VAT (EUR) |
|----------|--|---------------|------------|------------|---------|---------------------|
| 83531002 | Caret | Silk Grey | 1 pc | Stock item | 0.75 kg | 170 |
| 83531001 | Caret | Dark Burgundy | 1 pc | Stock item | 0.75 kg | 170 |
| 83502010 | Multi charging station for 24 portable lamps | | 1 pc | Stock item | 1.5 kg | 125 |
| 83520001 | Trolley *fits 3 trays | Black | 1 pc | Stock item | | 181 |
| 83501010 | Charging tray incl. power supply *12 lamps | Black | 1 pc | Stock item | | 545 |

Technical Specification

G4 1 Watt LED bulb, dimmable
 CRI: > 85
 Colour temperature (Kelvin): 2700K
 Light output: 100 lumen
 Charging time: 1 battery 3.5 hours – 2 batteries 6 hours
 Operating time in highest light setting:
 1 battery 11 hours – 2 batteries 20 hours
 Dimmability: 3 level touch dimmer on base 100% - 70% - 40 %
 Battery: Delivery with 1 battery. Replaceable (spare part)
 IP class: IP44 (This lamp is for indoors use only. It can be taken outdoors, but must be kept and stored indoors.)

Material: Lacquered metal, ABS

LED bulb included – replaceable (spare part).
 USB magnetic cable 200 cm/78.7in.

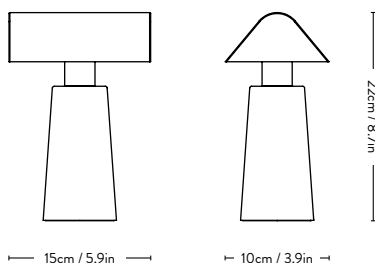

MF1

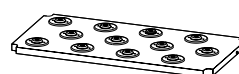

W: 43.8cm / 17.2in, L: 89cm / 35in, H: 2.8cm / 1.1in

Charging tray



W: 46cm / 18.1in, L: 102cm / 40.2in, H: 124cm / 47.2in

Trolley

Raku^{SH8} Sebastian Herkner 2022



| Item no. | Product | Variant | Colli qty. | Lead time | Weight | PRICE EX. VAT (EUR) |
|----------|--|----------------------|------------|------------|---------|---------------------|
| 23101601 | Raku | Blue Green & Brass | 2 pcs | Stock item | 0.80 kg | 215 |
| 23101691 | Raku | Beige Grey & Bronzed | 2 pcs | Stock item | 0.70 kg | 215 |
| 83502010 | Multi charging station for 24 portable lamps | | 1 pc | Stock item | 1.5 kg | 125 |
| 83520001 | Trolley *fits 3 trays | Black | 1 pc | Stock item | | 181 |
| 83501010 | Charging tray incl. power supply *12 lamps | Black | 1 pc | Stock item | | 545 |

Technical Specification

G4 1 Watt LED bulb, dimmable
 CRI: > 85
 Colour temperature (Kelvin): 2700K
 Light output: 100 lumen
 Charging time: 1 battery 3.5 hours – 2 batteries 6 hours
 Operating time in highest light setting:
 1 battery 11 hours – 2 batteries 20 hours
 Dimmability: 4 levels (100%, 70%, 40%, 0%)
 Battery: Delivery with 1 battery. Replaceable (spare part)
 IP class: IP44 (This lamp is for indoors use only. It can be taken outdoors, but must be kept and stored indoors.)

Material: Anodized aluminium or lacquered brass shade, ceramic with crackle glazed base, ABS

LED bulb included – replaceable (spare part).
 USB magnetic cable 200 cm/78.7in.

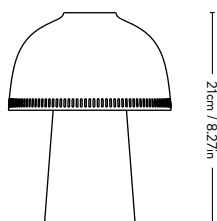

— Ø 16cm / 6.30in —
SH8

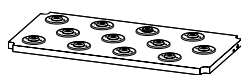

W: 43.8cm / 17.2in, L: 89cm / 35in, H: 2.8cm / 1.1in
Charging tray



W: 46cm / 18.1in, L: 102cm / 40.2in, H: 124cm / 47.2in
Trolley

Pivot^{ATD7} & Tradition 2023



| Item no. | Product | Variant | Colli qty. | Lead time | Weight | PRICE EX. VAT (EUR) |
|----------|--|-------------|------------|------------|--------|---------------------|
| 13500010 | Pivot | Rusty Mint | 2 pcs | Stock item | 0.8 kg | 249 |
| 13500020 | Pivot | Blue Silver | 2 pcs | Stock item | 0.8 kg | 249 |
| 83520001 | Trolley *fits 3 trays | Black | 1 pc | Stock item | | 181 |
| 83501010 | Charging tray incl. power supply *12 lamps | Black | 1 pc | Stock item | | 545 |

Technical Specification

G4 LED Max. 3W (3W LED Bulb is included)
 CRI: 80
 Colour temperature (kelvin): 2800K
 Light Output: 225 lumen/Watt
 Charging time: 16 hours
 Operating time in highest light setting: 20 hours
 Dimmability: 3 level touch dimmer 100% - 70% - 40%
 Battery: Replaceable (spare part)

Material: Painted or chrome plated metal, ABS

Micro USB charging cable 200cm/78.7in included.

LED bulb included - replaceable (spare part).

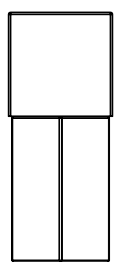

10cm / 3.9in

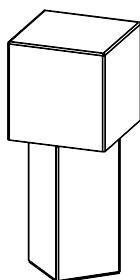

10cm / 3.9in

26cm / 10.2in

ATD7

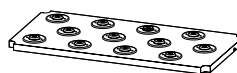

W: 43.8cm / 17.2in, L: 89cm / 35in, H: 2.8cm / 1.1in

Charging tray



W: 46cm / 18.1in, L: 102cm / 40.2in, H: 124cm / 47.2in

Trolley

Spare Parts

| Item no. | Product | Colour | Colli qty. | PRICE EX. VAT (EUR) |
|--------------|--|---------------------|------------|---------------------|
| BALDA50-1 | Canopy | White | 1 pc | 11 |
| BALDA51-1 | Canopy | Black | 1 pc | 11 |
| 20600230 | Canopy for wire suspension (SW3 + SC8) | White | 1 pc | 11 |
| 20600294 | Canopy for wire suspension (SW3 + SC8) | Black | 1 pc | 11 |
| BALDA70 | P376 Canopy KF1/KF2 | Matt White | 1 pc | 45 |
| BALDA71 | P376 Canopy KF1/KF2 | Alu | 1 pc | 45 |
| SP4010106 | Canopy VP1 Ø77 - 10 Pendants | Matt White | 1 pc | 454 |
| SP4010108 | Canopy VP1 Ø126 - 31 Pendants | Matt White | 1 pc | 681 |
| SP4010109 | Canopy VP10 Ø53 - 10 Pendants | Matt White | 1 pc | 341 |
| SP4010111 | Canopy VP10 Ø86 - 31 Pendants | Matt White | 1 pc | 568 |
| RV217000R | VP1, Stand | | 1 pc | 28 |
| RV217005 | VP1, VP6, Logo ring + screw thread | | 1 pc | 9 |
| RV217200R | VP3, Stand | | 1 pc | 33 |
| RV217205 | VP3, Logo ring + top ball | | 1 pc | 11 |
| RV217305 | VP4, Logo ring + screw thread | | 1 pc | 16 |
| RV207501 | VP9, Logo ring + top ball | | 1 pc | 11 |
| RV207502 | VP9 Logo ring + top ball, Grommet | Plated brass/Chrome | 1 pc | 11 |
| SP4010301 | VP10, Stand | | 1 pc | 22 |
| 200400-1 | Mega bulb shade (SR2) | Clear | 1 pc | 79 |
| 200500-1 | Mega bulb shade (SR2) | Silver | 1 pc | 79 |
| 200600-1 | Mega bulb shade (SR2) | Gold | 1 pc | 79 |
| RV203200 | Journey glass shade (SHY2) | Opal | 1 pc | 56 |
| SP83531001 | Caret shade (MF1) | Dark Burgundy | 1 pc | 28 |
| SP83531002 | Caret shade (MF1) | Silk Grey | 1 pc | 28 |
| SP83531001-1 | Caret base (MF1) | Dark Burgundy | 1 pc | 22 |
| SP83531002-1 | Caret base (MF1) | Silk Grey | 1 pc | 22 |
| 20820000-2 | Herman shade (SHY3) | Opal | 1 pcs | 85 |
| 20820000-1 | Herman base (SHY3) | Walnut, marble | 1 pcs | 255 |
| SP83529529 | Manhattan textile shade (SC52) | | 1 pc | 56 |
| SP23101601 | Raku shade (SH8) | Bronzed | 1 pc | 102 |
| SP23101691 | Raku shade (SH8) | Brass | 1 pc | 102 |
| SP23101601-1 | Raku Base (SH8) | Blue Green | 1 pc | 56 |
| SP23101691-1 | Raku Base (SH8) | Beige Grey | 1 pc | 56 |
| RV20951120 | G9 Glass diffuser (SHY2, SC6 Opal) | | 1 pc | 9 |
| SP25050129 | Collect Hurricane Glass Tube (SC83) | | 1 pc | 204 |
| SP13500010 | Pivot Shade (ATD7) | Rusty Mint | 1 pc | 102 |
| SP13500020 | Pivot Shade (ATD7) | Blue Silver | 1 pc | 102 |
| SP13500010-1 | Pivot Base (ATD7) | Rusty Mint | 1 pc | 102 |
| SP13500020-1 | Pivot Base (ATD7) | Blue Silver | 1 pc | 102 |
| 20991900-1 | Mist Shade Ø250mm (AP15) | Opal | 1 pc | 170 |

Spare Parts

| Item no. | Product | Colour | Colli qty. | PRICE EX. VAT (EUR) |
|--------------|--|-----------------|------------|---------------------|
| 20991901-1 | Mist Shade Ø370mm (AP16) | Opal | 1 pc | 295 |
| 20991902-2 | Mist Base (AP17) | Guatemala Verde | 1 pc | 272 |
| 20991902-1 | Mist Shade (AP17) | Opal | 1 pc | 273 |
| 20991902-2UK | Mist Base UK(AP17) | Guatemala Verde | 1 pc | 272 |
| SP25050172 | Montera Table Shade (JH42) | Forest/Sky | 1 pc | 170 |
| SP25050174 | Montera Table Shade (JH42) | Amber/Ruby | 1 pc | 170 |
| SP206330 | Fitting system (SW3) | White | 1 pc | 56 |
| SP206394 | Fitting system (SW3) | Black | 1 pc | 56 |
| SP2064030 | Fitting system (SW4) | White | 1 pc | 45 |
| SP2064094 | Fitting system (SW4) | Black | 1 pc | 45 |
| 20989990 | Oil kit for smoked oak | | 1 pc | 33 |
| 20989999 | Laminate Cleaning Kit | | 1 pc | 19 |
| 210608 | 1W light source (SC52, SC53, MF1, SH8) | | 1 pc | 11 |
| 210607 | 3W light source (JH27, ATD7) | | 1 pc | 6 |
| 210611 | 3W LED unit (VP9) | | 1 pc | 22 |
| 210610 | Battery (SC52, SC53, MF1, SH8, ATD7) | | 1 pc | 16 |
| 210612 | Battery (VP9) | | 1 pc | 22 |
| 210650 | Battery (JH27) | | 1 pc | 16 |
| 210613 | USB Cable (VP9) | | 1 pc | 11 |
| 210616 | USB Magnetic cable (SC52, SC53, MF1, SH8, VP9) | | 1 pc | 11 |
| 210618 | USB cable (Lucca SC51) | | 1 pc | 11 |
| 210651 | USB cable (Setago JH27) | | 1 pc | 11 |
| 210614 | Plug Adapter (EU) | | 1 pc | 11 |
| 210614UK | Plug Adapter (UK) | | 1 pc | 11 |
| SP3008901 | Cord (textile) | Grey Beige | 1m | 5 |
| SP2070300 | Cord (textile) | White | 1m | 5 |
| SP2070940 | Cord (textile) | Black | 1m | 5 |
| SP3009102 | Cord (textile) | Matt Light Grey | 1m | 5 |
| SP3012300 | Textile Cable | White | 6m | 31 |
| SP3012940 | Textile Cable | Black | 6m | 31 |
| SP3012201 | Textile Cable | Mustard | 6m | 31 |
| SP3013401 | Textile Cable | Vermilion Red | 6m | 31 |
| SP3013501 | Textile Cable | Tangy Pink | 6m | 31 |
| SP3013601 | Textile Cable | Dark Plum | 6m | 31 |
| SP3013701 | Textile Cable | Swim Blue | 6m | 31 |
| SP3015002 | Textile Cable | Cobalt Blue | 6m | 31 |
| SP3018901 | Textile Cable | Grey Beige | 6m | 31 |
| SP3019102 | Textile Cable | Matt Light Grey | 6m | 31 |

Spare Parts

| Item no. | Product | Colour | Colli qty. | PRICE EX. VAT (EUR) |
|-----------|---------------|--------------|------------|------------------------|
| SP3019202 | Textile Cable | Stone Blue | 6m | 31 |
| SP3019201 | Textile Cable | Signal Green | 6m | 31 |

Material care & cleaning

We challenge convention to create objects that rethink how we use materials and manufacturing techniques. We find beauty in objects that can be created by the latest industrial processes as well as those that maintain techniques that have evolved over a long period of time. We strive for timeless beauty and quality that is made to last.

Find below information about the materials and finishes used in the collection as well as guidelines for daily care, cleaning and maintenance.

Oiled oak & walnut

Oiled oak & walnut, whether solid or veneered, is a fundamental material in the &Tradition collection.

To a greater extent than lacquering and staining, oiling leaves the wood feeling and looking natural and still offers a good surface protection. Oiled wood will develop a natural patina and character over time which will only enhance the beauty of the material.

Solid oak and oak veneer is oiled using either white pigmented oil or a dark smoked oil. The white pigmented oil allows the oak to maintain its original and natural light colour for longer and thereby protects the wood from premature darkening and turning yellow. The smoked oil offers a unique dark finish and character. Variations in wood structure and colour are natural characteristics of solid oak. This feature is further enhanced when applying the smoked oil and should be seen as part of the overall product.

For daily care, dust oiled furniture with a soft dry cloth. Cleaning can be done using a soft cloth wrung in lukewarm water following the wood grain and dried immediately with a soft cloth following the wood grains. For more severe cleaning, a soap specifically developed for oiled wood can be used. Follow the instructions on the packaging of the cleaning product.

Solid walnut or walnut veneer is oiled using a natural coloured oil to maintain its original colour for longer and thereby protect the wood. To maintain the look and silky feeling of oiled wood, regular re-oiling is recommended. Re-oiling should be done when the wood starts to appear dry or faded. Usually, re-oiling once a year is sufficient. Re-oiling walnut can be done by applying standard natural oil for indoorwood products.

Avoid use of cleaning detergents and abrasive cleaning agents as they may damage the surface of the oiled wood. Avoid placing wooden furniture in direct sunlight, excessive heat or humidity.

Lacquered or stained wood

Lacquered or stained wood offers a stronger surface than oiling and is also effective when coloured surfaces are desired. Compared to oiled wood, lacquered and stained wood is easier to clean and requires minimal maintenance.

For daily care it is recommended to dust the furniture with a soft cloth. Lacquered and stained wood can be cleaned with a soft cloth wrung in a mild solution of lukewarm water and a universal cleaning detergent. Always follow the wood grains and always dry with a soft dry cloth immediately after cleaning.

Avoid use of abrasive cleaning agents and aggressive cleaning detergents as this will damage the surface of the lacquered or stained wood. Avoid placing wooden furniture in direct sunlight, excessive heat or humidity.

Linoleum

Tabletops with linoleum offers a soft touch surface that does not feel as cold and hard as laminate. Regular cleaning is done with a soft cloth wrung in a mild solution of lukewarm water and a universal cleaning detergent.

Avoid placing sharp objects on the surface as this may scratch the tabletop. It is recommended to use trivets or coasters under flowerpots, vases, cups etc.

Fenix NTM Nano laminate

Fenix NTM Nano laminate is a soft touch laminate based on nano technology and is used for tabletops as an alternative to linoleum and standard laminate. The nano laminate offers unique features such as scratch resistance, soft touch, low light reflectivity, antifingerprint and much more.

For more details about the unique properties of nano laminate, as well as cleaning and maintenance refer to: www.fenixntm.com/en

Lacquered & Powder coated metal

The majority of the lighting products in the &Tradition collection have a lacquered or powder coated surface.

The True Colour vases have a protective lacquered finish and some furniture has powder coated parts. These surfaces are durable, require no maintenance and offer an endless palette of colours, textures and gloss.

It is recommended only to use a soft, dry cloth to clean lacquered and powder coated surfaces but in case more severe cleaning is necessary, a soft cloth wrung in lukewarm water can be carefully applied. Always dry immediately after cleaning with a soft, dry cloth. Avoid using abrasive cleaning agents or aggressive cleaning detergents on lacquered or powder coated surfaces as this may permanently damage the surface.

Stainless steel

Stainless steel is used on both lighting products and furniture in either a mirror-polished or satin-polished finish. Stainless steel is a classic strong corrosion resistant material that requires no surface protection and will not change appearance over time.

Dust stainless steel products for daily care using only a soft, dry cloth. Cleaning of stainless steel should be done only by using a cleaning detergent specifically for stainless steel. Follow the instructions on the packaging. Cleaning agents not developed specifically for stainless steel may permanently damage the surface of the stainless steel and should never be used.

Brass & Copper

Brass and copper is used for both lighting products and furniture in either a mirror-polished or satin-polished finish. Depending on the product, the brass and copper may be coated using a transparent lacquer or left untreated. Coated brass and copper will not change appearance over time whereas uncoated brass and copper will develop a unique and beautiful patina, over time adding character to the product.

For daily cleaning of coated brass and copper it is recommended only to use a soft dry, cloth. For removal of stains, a soft cloth wrung in lukewarm water can be carefully applied. Always dry immediately after with a soft dry cloth. For daily cleaning of uncoated brass and copper it is recommended only to use a soft, dry cloth. In case a patina of the material is not desired, the material can be regularly cleaned and polished using a detergent specifically for brass and copper.

Avoid using abrasive cleaning agents or aggressive cleaning detergents on coated and uncoated brass and copper as this will permanently damage the surface.

Anodised aluminium

The aluminium used on the column shelves is either anodized black or in a natural

Material care & cleaning

hand polished finish which is treated with a protective wax. Both versions can be cleaned using a soft cloth wrung in lukewarm water. Always dry immediately afterwards with a soft cloth. Avoid use of abrasive cleaning products such as steel wool or polish. Never use aggressive or abrasive cleaning detergents for any parts of the shelf, as this will cause irreparable damage.

Marble & Travertine

Marble and travertine are used in the &Tradition collection on both lighting products and furniture.

The natural material offers a distinctive and exclusive look and two items will never look the same.

The marble and travertine used on &Tradition tabletops are treated with a sealer which makes the tabletop more stain resistant than when left untreated. However, it is strongly recommended to always use a trivet and not to place glasses or cups with liquids directly onto the tabletop. As natural materials, marble & travertine are sensitive to liquids and if not removed immediately, spilled liquids will leave a permanent stain on the tabletop.

For daily care and cleaning it is recommended to use a cleaning agent specifically developed for stone or marble. It is also highly recommended to do a re-sealing of the tabletop approximately every second month using an appropriate sealer developed specifically for stone or marble. The marble used on lighting products has no surface protection and is therefore more exposed to stains and marks. If possible, it is recommended only to clean marble on lighting products with a soft, dry cloth. In case more severe cleaning is necessary, use a cleaning agent specifically developed for stone or marble. Avoid using abrasive cleaning agents or aggressive cleaning detergents on marble as this will permanently damage the surface.

Glass

Glass, in various colours and shapes, is an important material in the &Tradition lighting collection. All glass is mouth-blown and hand crafted which ensures that each item is unique and displays individual characteristics. Examples of characteristics of mouth-blown glass are minor air bubbles and variations in form and thickness.

A number of the glass products in the lighting collection are coloured in silver and gold tones using a traditional luster painting technique. Luster is applied with a brush to the clear glass by skilled craftsmen and the glass is subsequently burned at +450°C to melt the luster colour into the glass mass. The process ensures a very smooth and highly scratch resistant surface. Since the entire process of applying the luster is performed by hand, slight deviations in colour may occur from item to item. Daily cleaning of glass is best done using a soft, dry cloth. If more severe cleaning is necessary, it is recommended to use a soft cloth with a standard glass cleaning detergent and then to follow by drying with a soft, dry cloth. Avoid using abrasive cleaning agents on the glass as this will damage the surface.

Collect glassware

Normal dishwasher liquid can be used and all items are dishwasher safe (max. 50°). Do not use any cleaning detergents with harsh chemicals or abrasives.

For more severe cleaning, soaking the product overnight in water and vinegar is recommended.

Mirror

Use household glass cleaner for the mirror. To avoid damaging the surface of the mirror frame, always spray the glass cleaner onto a soft cloth and clean the mirror.

Plastic

For daily cleaning it is recommended to use a soft cloth wrung in lukewarm water. For more severe cleaning a mild detergent can be used. Always dry immediately after.

Upholstery webbing

We recommend maintaining braided upholstery webbing regularly, as dirt and dust etc. will cause wear and tear on the material through use.

General Maintenance

We recommend that you vacuum upholstery webbing once a week using the soft nozzle attachment of your vacuum cleaner (used for textiles and softer furnishings) in order to ensure the longest possible life of the product.

It should not be necessary to clean upholstery webbing often as the material has a slightly dirt-repellent surface.

Stain removal

If an accident occurs and cleaning or stain removal is necessary, the following applies:

- The faster a stain is treated, the greater the possibility that the stain can be removed.
- Spilled liquids should be dabbed – not scrubbed – with a clean, lint-free cloth wrung in clean and lukewarm water, as soon as possible.
- Regardless of the size of the stain, it is important that you clean it working from the outer edge of the stain and move in towards the centre of the stain, so that the damaged area is reduced as much as possible.
- You should not rub or scrub the material as this can damage the material's colour, structure and strength which can worsen the state of the stain.
- If a stain has dried, is from a firmer substance, or has greasy contents, it may be possible to scrape off the stain residue with a blunt knife or a spatula, before continuing any necessary treatment with a suitable stain remover.
- When using a suitable stain remover on a small area, you should carefully follow the manufacturer's instructions for use. It is recommended to test the stain remover on a less visible area of the material first – before cleaning the affected area – to see if the product works as intended, or to see if the product damages the webbing.
- If a stain is very big or has soaked into and through the material, it is recommended to contact a professional furniture cleaner before trying to remove the stain yourself, as it may require a special treatment depending on the nature and location of the stain.

Disclaimer

- Do not use solvents, undiluted detergents, soaps, bleaches or ammonia on the material.
- Please be aware that especially new non-colourfast clothing and dark jeans can potentially leak colour onto the webbing. Any such leakage may not be possible to remove, as the excess colour can soak deep into the material.

Handloomed-woven rugs

The rugs in the &Tradition collection are handmade in India by skilled craftsmen using carefully selected natural materials. Being handmade, each rug will have its own unique character and therefore the patterns and colours of two rugs will never be identical.

A new rug will shed excess fibers that were not fully spun into the yarn during spinning. This is normal and over time, the shedding will lessen and eventually stop.

To prolong the lifetime of a rug, it is highly recommended to use a rug underlay. An underlay ensures that the rug remains in a fixed position and will also reduce the risk of staining.

For daily care, vacuum the rug regularly to keep it free from fluff and dust or sand particles which will wear and tear the rug over time if not removed. Spots can be attempted to be removed by dabbing very gently with a damp cloth soaked in carbonated water. In case more thorough cleaning is necessary, professional cleaning is recommended.

Placing a rug in direct sunlight is not recommended as it will fade the colours of the rug over time.

Sheepskin

Easy on the eye and soft to the touch, sheepskin makes for exceptional and hard-wearing upholstery. It is defined by a dense and curly fleece that comes intact in its most natural form, where pieces are distinctly unique, and their look varies from product to product.

As with most natural materials, differences in structure, density and thickness are expected, as two pieces of sheepskin never look identical and tend to show natural variations in both curls and tones.

Please note that the wool's fibres might naturally become entangled in time. And in regards to colour, each skin's ability to maintain its original tone or absorb applied dye might vary, especially if exposure to sunlight is high. We recommend to keep sheepskin-upholstered products away from direct sunlight to avoid discolouring.

In order to preserve the skin's highly tactile, soft nature, we suggest vacuum cleaning on a weekly basis, and when stained, spots should be soaked with water as promptly as possible. For bigger stains, place a clean towel on the spill and let it absorb as much liquid as possible. For cleaning, we recommend the use of a sponge, lukewarm water and mild wool detergent.

Leather

Imperfect Beauty

High quality, natural leather is not flawless. &Tradition leather, like all other top-quality leather, may have some minor visible marks from the natural life of the animal. These characteristics give each &Tradition leather product a unique beauty and charm but do not affect the overall strength or durability of the product.

&Tradition has distinct quality standards for which these markings are acceptable. Varying degrees of markings are permitted according to how visibly they appear on the product as a whole.

The aniline leather NOBLE is surface treated with a very thin layer of wax which makes it possible for the material to 'breathe'. The semi-aniline leather TAILOR is slightly buffed and lightly surface treated which makes the leather more durable and ensures a higher lightfastness.

Natural Characteristics

Typical natural characteristics which may be visible on the leather are:

- Fat creases
- Neck wrinkles/spine marks
- Healed scars
- Vein marks
- Insect bites
- Slight colour differences from one leather hide to another
- Variation in the natural grain from one hide to another, and sometimes even within a singular hide

Patina

Aniline leather will age beautifully, with each piece gaining its own patina. Over time, the natural leather will continue to develop a slightly different tone and as part of its unique appeal, it will not look exactly the same as on the day it was originally bought.

Before Use

Leather furniture should not be exposed to direct sunlight, positioned close to heat sources or kept in very dry or highly airconditioned environments. This is a natural material which does not perform well when put under these conditions and doing such may result in the leather drying out and becoming stiff and inflexible.

Maintenance

To prolong the life of the leather it is important to frequently vacuum with a soft brush or gently wipe with a soft, dry cloth.

Never use cleaning detergents or sharp objects on the leather as this may damage the surface.

Instead of trying to remove minor spots or stains, they should be left untreated as

over time they should fade and disappear.

Care

The natural material should be treated with a special aniline leather care cream at least four times a year.

Aniline leather gets dry over time, so it is important to keep the leather conditioned and moisturised to retain optimal softness, flexibility and seating comfort.

Follow the instructions of the special care product; apply cream on a soft, lint-free cloth, massage in light circular motions from seam to seam on the furniture component. Let dry before taking in to use.

Cleaning

Cleaning is done under customer's own responsibility

If leather is soiled, it should be wiped with a soft, clean, damp, lint-free cloth wrung in lukewarm, demineralised water. Alternatively, you can attempt to absorb as much liquid as possible from the soaked leather with a clean kitchen towel.

Do not spot clean leather - clean the entire surface from seam to seam.

Never scrub the leather in an isolated area as this will discolour and tear the material.

If extensive cleaning is needed, it is recommended to use a solution of clean boiled water or demineralised water with a dilution of mild, natural, high-quality soap flakes:

1. Use 0,5DL soap flakes for 1L water. Whip soap flakes in the water until fully dissolved.
2. When the solution is lukewarm, the foam must be gently rubbed onto the leather surface with a soft, clean, cotton cloth using circular motions. It is essential that only the foam from the solution is used. Make sure the foam is equally distributed on the whole surface from seam to seam. Be sure to never soak the surface.
3. When the furniture is dry, the leather should be polished with a very soft, lint-free cloth.
4. After cleaning, it is necessary to apply a special leather care cream.

Large Spills or Damages

If large areas are soiled or the surface is very damaged, contact a professional cleaning firm.

Rattan

In order to retain the strength and flexibility of rattan wicker the material needs to be maintained with a soap treatment 10-12 times a year using the following solution:

- Prepare 1 teaspoon of soap flakes dissolved in 1 litre of lukewarm water.
- Spray the solution on both the front and the back of the rattan and allow it to penetrate.
- If needed, wipe away any leftover liquid with a damp cloth.

Rattan has a delicate white expression when new. This will develop over time, darkening and forming a beautiful patina.

Velvet

Dry stain and soil

On all the articles in our living environment dust and dirt will settle. So it happens also on our upholstered furniture. Do not allow the dust and dirt become to excessive, otherwise it will be more difficult to remove. The upholstered furniture should be cleaned regularly to ensure prolonged life and appearance.

The best way for regular maintenance is: Vacuum cleaning and brushing. Vacuum cleaning and brushing, with a hard cloth brush, always in the direction of the pile naps. To remove stain or in case of fundamental cleaning from your upholstery you better can contact your local upholstery cleaning specialist. You can obtain addresses from

your local Consumer Enquiry Office.

They have the experience in dry shampooing and that kind of cleaning processes.

Wet staining

Liquids can be removed by dabbing with paper towel, a clean tea cloth or kitchen towel. Don't rub, only dabbing! For hot liquids you do the same, but there is less rescue time between messing and dabbing. The hot fluid penetrates much quicker in the fabric than cold liquids.

To remove food you scrape the dirt with a spoon or a knife from the fabric and dab the stain with a cold solution of water and detergent. Don't use hot cleaning liquid, because coloured components of the stain will more penetrate the fabric at higher temperature and stay there.

We can't give a general advice about removing Ink, paints, etc. This kind of staining, mostly you can use a solvent as alcohol, dry cleaning solvents or something like that. Look in a local stain removal advisory table for the best solution.

Note: The S-finish (Teflon) is a release finish with additional a temporary repellent effect, that brings you rescue time between making the mess and removing it. It gives you a delay time, but it don't prevent staining or fouling.

Note: We don't have enough 'local knowledge' about the composition of food, drinks and other frequent used products which may cause staining of your upholstery fabric. Please contact your local cleaning specialist or look at a local website for stain remove advisory tables.











Flattening out pile naps











On velvets, which are not regularly maintained, certain wellworn areas will be formed and will show pile tangling over a period of time. Depending on the colour, you will see it as a change of shade.

By sitting you exert a pressure on the velvet fabric forcing the pile naps in any direction. In combination with heat, the rising air humidity, the body moisture and the kind of filling material under the velvet the changes direction of the pile naps is 'partly fixed'. You can notice this as a change of shade. This is a typical property of velvet fabric and it is neither a defect or a sign of low quality.

You can treat this marks of wear and tear as follows: Take a clean, white/not coloured, warm, damp piece of cloth and lay it several hours or a night over the velvet. The moisture will restore the cotton velvet. The upholstery velvet should not be used before it is complete dry!

Colour Overview

| | Flowerpot | | | | | | Topan | Spinning | | Como | |
|-----------------|---|---|---|---|---|---|---|---|---|---|---|
| |  |  |  |  |  |  |  |  |  |  |  |
| VP1 | VP7 | VP2 | VP3 | VP4 | VP8 | VP9 | V6 | BH1 | BH2 | SC53 | |
| Mustard | • | • | | • | | • | • | | | | |
| Red Brown | | | | | | | | | | • | |
| Stone Blue | • | • | • | • | | | • | | | • | |
| Grey Beige | • | • | • | • | | • | • | • | | | |
| Signal Green | • | • | | • | | • | • | | | | |
| Matt Black | • | • | • | • | • | • | • | • | • | • | |
| Matt White | • | • | • | • | • | • | • | | | | |
| Matt Light Grey | • | • | | • | | • | • | | | | |
| Black & White | • | • | • | | | | | | | | |
| Cobalt Blue | • | • | | • | | | • | | | | |
| Swim Blue | • | • | | • | | | • | | | | |
| Vermilion Red | • | • | • | • | | • | • | • | | | |
| Tangy Pink | • | • | | • | | | • | | | | |
| Dark Plum | • | • | | • | | | • | | | | |

| | Bellevue | | | Copenhagen | | | Tripod | | Lucca | Tabata | Caret |
|---------------|---|---|---|---|---|---|---|---|---|---|---|
| |  |  |  |  |  |  |  |  |  |  |  |
| AJ7 | AJ9 | AJ11 | SC6 | SC7 | SC8 | HM8 | HM9 | SC51 | LN10 | MF1 | |
| Black | • | • | • | | | | | | | | |
| Matt Black | | | | • | • | • | • | • | • | | |
| Maroon | | | | | | | | • | | | |
| Moss | | | | | | | | • | | | |
| Silk Grey | | | | | | | | | • | • | |
| Dark Burgundy | | | | | | | | | • | • | |

*Variations in colours might occur.

Packaging Information

| Product | Product code | Category | Height cm | Width cm | Depth cm | Weight | Colli qty. |
|--------------|---------------------|---------------------|-----------|----------|----------|----------|------------|
| P376 | KF1 | Pendant | 27 | 59 | 59 | 4.00 kg | 1 pc |
| P376 | KF2 | Pendant | 37 | 80 | 80 | 7.50 kg | 1 pc |
| Blown | SW3 | Pendant | 40 | 32 | 32 | 4.30 kg | 2 pcs |
| Blown | SW4 | Pendant | 30 | 25 | 25 | 2.65 kg | 2 pcs |
| Blown | SW5 | Ceiling Lamp | 40.5 | 30 | 30 | 4.10 kg | 2 pcs |
| Passepartout | JH10 | Lamp Shade | 23 | 19 | 18 | 0.85 kg | 1 pc |
| Passepartout | JH11 | Lamp Shade | 22 | 24.5 | 24 | 0.95 kg | 1 pc |
| Passepartout | JH10 & JH11 | LED Module | 8.4 | 11.3 | 11.3 | 0.25 kg | 1 pc |
| Passepartout | JH12 | Lamp Shade | 21 | 30.5 | 30 | 2.00 kg | 1 pc |
| Passepartout | JH12 | LED Module | 8.4 | 11.3 | 11.3 | 0.25 kg | 1 pc |
| Tabata | LN10 | Wall Lamp | 32 | 24.5 | 16.5 | 2.20 kg | 1 pc |
| Colette | ATD6 | Table Lamp | 18 | 40 | 54 | 3.00 kg | 1 pc |
| Formakami | JH3 | Lamp Shade | 10 | 49 | 49 | 0.72 kg | 2 pcs |
| Formakami | JH3 | Lamp Bracket | 8 | 19 | 45.5 | 0.67 kg | 2 pcs |
| Formakami | JH4 | Lamp Shade | 10 | 52 | 52 | 0.80 kg | 2 pcs |
| Formakami | JH4 | Lamp Bracket | 7.5 | 17 | 34 | 0.63 kg | 2 pcs |
| Formakami | JH5 | Lamp Shade | 10 | 72 | 73 | 1.60 kg | 2 pcs |
| Formakami | JH5 | Lamp Bracket | 7.5 | 23 | 48.5 | 0.71 kg | 2 pcs |
| Formakami | JH18 | Lamp Base | 14 | 14 | 49 | 1.12 kg | 2 pcs |
| Formakami | JH18 | Lamp Shade | 4.8 | 40 | 48.5 | 0.39 kg | 2 pcs |
| Setago | JH27 | Portable Table Lamp | 23.5 | 46 | 30 | 4.00 kg | 2 pcs |
| Bellevue | AJ7 | Floor Lamp | 176 | 28.5 | 28.5 | 10.30 kg | 1 pc |
| Bellevue | AJ9 | Wall Lamp | 20 | 45 | 19.5 | 1.15 kg | 1 pc |
| Bellevue | AJ11 | Plug in Table Lamp | 95 | 20 | 20 | 2.30 kg | 1 pc |
| Flowerpot | VP10 | Pendant | 20.5 | 20.5 | 15.7 | 0.98 kg | 2 pcs |
| Flowerpot | VP10 canopy, 10 pcs | Chandelier | 15 | 58.5 | 58.5 | | 1 pc |
| Flowerpot | VP10 canopy, 31 pcs | Chandelier | 15 | 99 | 99 | | 1 pc |
| Flowerpot | VP1 | Pendant | 15 | 24.5 | 25 | 1.45 kg | 2 pcs |
| Flowerpot | VP1 canopy, 10 pcs | Chandelier | 15 | 82 | 82 | | 1 pc |
| Flowerpot | VP1 canopy, 31 pcs | Chandelier | 15 | 133 | 133 | | 1 pc |
| Flowerpot | VP7 | Pendant | 45 | 45 | 28 | 3.95 kg | 1 pc |
| Flowerpot | VP2 | Pendant | 31 | 53 | 53 | 5.00 kg | 1 pc |
| Flowerpot | VP3 | Table Lamp | 45 | 29 | 26 | 4.80 kg | 1 pc |
| Flowerpot | VP4 | Table Lamp | 40 | 25.5 | 25.5 | 1.85 kg | 1 pc |
| Flowerpot | VP8 | Wall Lamp | 26 | 40 | 28 | 1.72 kg | 1 pc |
| Flowerpot | VP9 | Portable Table Lamp | 36 | 42 | 33 | 3.90 kg | 2 pcs |
| Topan | VP6 | Pendant | 28.5 | 45.5 | 23.5 | 2.14 kg | 2 pcs |
| Utzon Lamp | JU1 | Pendant | 25.5 | 24.5 | 24.5 | 1.60 kg | 1 pc |
| Copenhagen | SC6 | Pendant | 28.5 | 24.5 | 24.5 | 1.70 kg | 2 pcs |
| Copenhagen | SC6 - Opal glass | Pendant | 31.5 | 26.5 | 26.5 | 1.30 kg | 2 pcs |

Packaging Information

| Product | Product code | Category | Height cm | Width cm | Depth cm | Weight | Colli qty. |
|------------------------|--------------------------------|-----------------------|-----------|----------|----------|----------|------------|
| Copenhagen | SC6 - Acrylic diffuser | Pendant | 0.2 | 14 | 14 | 0.04 kg | 2 pcs |
| Copenhagen | SC7 | Pendant | 44 | 40.5 | 40.5 | 2.50 kg | 1 pc |
| Copenhagen | SC7 - Opal glass | Pendant | 45 | 42 | 42 | 3.90 kg | 1 pc |
| Copenhagen | SC7 - Acrylic diffuser | Pendant | 0.2 | 26.5 | 26.5 | 0.14 kg | 1 pc |
| Copenhagen | SC8 | Pendant | 60 | 65 | 65 | 7.20 kg | 1 pc |
| Copenhagen | SC8 - Acrylic diffuser | Pendant | 0.2 | 47.5 | 47.5 | 0.45 kg | 1 pc |
| Copenhagen | SC13 - Shade | Table lamp | 31 | 41 | 41 | 3.40 kg | 1 pc |
| Copenhagen | SC13 - Base | Table lamp | 16 | 48 | 26 | 3.90 kg | 1 pc |
| Copenhagen | SC14 - Shade | Floor lamp | 39 | 59 | 59 | 5.30 kg | 1 pc |
| Copenhagen | SC14 - Base | Floor lamp | 17 | 158 | 39 | 11.80 kg | 1 pc |
| Spinning | BH1 | Pendant | 52 | 32 | 32 | 2.15 kg | 1 pc |
| Spinning | BH2 | Pendant | 41 | 49 | 49 | 2.50 kg | 1 pc |
| Mega Bulb | SR2 | Pendant | 29.5 | 22 | 22 | 1.45 kg | 2 pcs |
| Journey | SHY1 | Table Lamp | 31.5 | 25.5 | 32.5 | 2.60 kg | 2 pcs |
| Journey | SHY2 | Wall Lamp | 31.5 | 25.5 | 32.5 | 2.30 kg | 2 pcs |
| Herman | SHY3-Shade | Table Lamp | 18 | 32 | 32 | 1.9 kg | 2 pcs |
| Herman | SHY3-Base | Table Lamp | 20 | 21 | 34 | 2.3 kg | 2 pcs |
| Montera | JH42 | Table lamp | 29 | 50 | 27 | 4.30 kg | 2 pcs |
| Mist | AP15 | Pendant | 33 | 33 | 23 | 2 kg | 2 pcs |
| Mist | AP16 | Pendant | 45 | 45 | 30 | 2 kg | 2 pcs |
| Mist | AP17-Shade | Table Lamp | 35 | 48 | 48 | 4.2 kg | 1 pc |
| Mist | AP17-Base | Table Lamp | 35 | 18 | 18 | 8.3 kg | 1 pc |
| Tripod | HM8 | Floor Lamp | 147 | 52 | 58 | 16.00 kg | 1 pc |
| Tripod | HM9 | Table Lamp | 30 | 51 | 26 | 0.9 kg | 1 pc |
| Lucca | SC51 | Outdoor Portable Lamp | 37 | 46 | 27 | 3.50 kg | 2 pcs |
| Manhattan | SC52 | Portable Lamp | 33 | 18 | 18 | 1.25 kg | 1 pc |
| Como | SC53 | Portable Lamp | 29 | 21 | 21 | 1.00 kg | 1 pc |
| Caret | MF1 | Portable Lamp | 31 | 17.5 | 17.5 | 1.34 kg | 1 pc |
| Raku | SH8 - Brass | Portable Lamp | 31 | 45 | 21 | 1.4 kg | 2 pcs |
| Raku | SH8 - Bronzed | Portable Lamp | 31 | 45 | 21 | 1.2 kg | 2 pcs |
| Pivot | ATD7 | Portable Lamp | 15 | 25 | 21 | 2 kg | 2 pcs |
| Trolley | SC52, SC53, MF1, SH8,VP9, ATD7 | Trolley | 42 | 100 | 57.5 | 23 kg | 1 pc |
| Charging tray | SC52, SC53, MF1, SH8, ATD7 | Charging Tray | 49 | 7 | 96 | 7.80 kg | 1 pc |
| Charging tray | VP9 | Charging Tray | 58 | 99 | 14 | 7.80 kg | 1 pc |
| Multi charging station | SC52, SC53, MF1, SH8,VP9, ATD7 | Power Supply | 7 | 20 | 26 | 1.70 kg | 1 pc |

General Terms & Conditions for Sales (B2B)

These general terms and conditions for sales ("GTCs") shall govern all purchase orders ("Order" or "Orders") placed with &Tradition A/S, CVR-nr. 18169304, Kronprinsessegade 4, 1306 Copenhagen K, Denmark ("&Tradition"), unless otherwise explicitly agreed in writing between the buyer ("Buyer") and &Tradition.

1. Prices

1.1. All prices in the price list are recommended resale prices. &Tradition reserves the right without prior notice and with immediate effect to change the recommended resale prices.

2. Quotations

2.1. Any quotation given by &Tradition will be valid 60 days from the date of issuance, unless otherwise stated.

3. Order Handling and Confirmation

3.1. Orders must be sent to info@andtradition.com or to the Buyer's assigned sales representative.

3.2. Orders shall not be binding on &Tradition until the Buyer has received &Tradition's written order confirmation.

3.3. The Buyer must review the order confirmation immediately upon receipt thereof and report any errors within 24 hours to &Tradition on info@andtradition.com or +45 3920 0233.

4. Changes and Cancellations of Orders

4.1. Orders can be changed or cancelled in accordance with below rules:

4.1.1. Stock products (standard collection)

For stock products, the Buyer may change or cancel the Order within 24 hours from receipt of the order confirmation. Changes or cancellations later than 24 hours are not possible.

4.1.2. Non-stock products (standard collection)

For non-stock products (standard collection), the Buyer may change or cancel the Order within 72 hours from receipt of the order confirmation.

4.1.3. Customized products

For customized products changes or cancellations are not possible.

5. Terms of Payment

5.1. Payment is 14 days net from invoice date.

5.2. Conditions of payment and payment procedures are stated in the order confirmation and invoice.

5.3. &Tradition reserves the right at any time to demand full or partial advance payment on Orders.

5.4. In case of late payment, interest will be charged at a rate of 1.5% per month or part thereof as of the due date.

5.5. Furthermore, &Tradition reserves the right to suspend a Buyer's account if the Buyer's balance is due, in which event no Orders or deliveries to the Buyer will be processed.

6. Reservation of Title

6.1. Delivered products remain the property of &Tradition and &Tradition will retain full title over the delivered products until the full invoiced amount including delivery charges as well as interest payable in arrears is fully paid. The Buyer shall be obliged to clearly mark the delivered products as being the property of &Tradition until full payment has been made.

6.2. Additional and specific terms on retention of title applicable to the Order may be set out in the quotation, order confirmation, delivery note and/or invoice.

7. Terms of Delivery

7.1. The shipment date of the Order will be stated on the order confirmation.

7.2. If the Order cannot be shipped in accordance with the stated delivery date, &Tradition will inform the Buyer without undue delay and inform the new shipment date and send an updated order confirmation to the Buyer. Only if the delay exceeds 3 months and is not due to force majeure, the Buyer is entitled to cancel the Order. The Buyer is not entitled to make further claims against &Tradition in cases of delay.

7.3. The lead times as stated in &Tradition's price list in force from time to time can only be used as indicative.

8. Delivery Costs

8.1. Delivery costs for the Order will be stated in the order confirmation.

8.2. Delivery costs are calculated on basis of the total Order amount and will be charged for each shipment.

9. Transportation

9.1. Standard Delivery

9.1.1. The standard delivery term is DAP (Incoterms 2020), and Orders will be shipped from &Tradition or its affiliated warehouses or directly from its suppliers. &Tradition will confirm on the order confirmation if DAP delivery is possible.

9.1.2. Delivery can only happen to shop or warehouse addresses during weekdays and normal working hours of the Buyer.

9.1.3. The Buyer must inform &Tradition of all relevant information related to the Buyer's ability to receive the Order, e.g. if the transportation must be carried out with a big or small lorry, with or without a fork lift, opening hours etc. Any failure to inform &Tradition thereof which consequently results in a failed delivery will be imposed a charge cf. 9.1.4.

9.1.4. In events where the Buyer needs a fixed delivery date and/or slot for the Order, redelivery due to failed delivery attempt of an Order, change of delivery address and/or change to Orders after the deadlines defined in these GTCs additional costs will be charged the Buyer.

9.1.5. A fixed delivery date and/or slot must be informed and accepted by &Tradition in advance of placing the Order and shall be considered agreed when stated in the order confirmation.

9.2 Non-standard Delivery

9.2.1. Where standard delivery is not possible or offered, the delivery term is EX-WORKS (Incoterms 2020) at a designated address, such to be accepted by &Tradition in advance.

9.2.2. EX-WORKS Orders will as standard be packed for SEA-freight. If the Buyer wishes the Order packed for AIR-freight, such must be informed and accepted by &Tradition in advance of placing the Order and shall be considered agreed when stated in the order confirmation.

9.2.3 The Order must be collected at the designated location as stated in the order confirmation no later than 30 days after the delivery date. Any delay in picking up the Order will be charged a fee per week of delay.

9.2.4. If the Order hasn't been collected within 60 days from the delivery date this will be deemed as if the Buyer has cancelled the Order, in which event the Buyer will be charged the total Order amount and other incurred costs related to the rearrangement of the packing and shipping of the Order.

10. Inspection of Orders upon Delivery and Claims

10.1. The Buyer is obliged to inspect the Order upon delivery and check that the number of packages corresponds with the delivery note and that the packaging and products are free from visual defects.

10.2. If a delivery does not comply with the corresponding Order or delivery note, or if the products received appear to have been damaged during transportation, the Buyer must ensure to record a reservation on the delivery document upon receipt or alternatively reject receipt of the Order. If reservation is made subject to receipt of the Order, this must be as specific as possible and include photo documentation of all visual damages in accordance with the claims procedure outlined below. &Tradition shall have the right to reject all claims in connection with visual damages and/or quantity errors if

General Terms & Conditions for Sales (B2B)

the Buyer has not made a reservation on the delivery document.

10.3. Claim Procedure

10.3.1. The Buyer must notify &Tradition of any claims related to clause 10.2. no later than 2 calendar days after delivery of the Order by sending an e-mail to info@andtradition.com informing:

- Sales order number or invoice number;
- Purchase order no. (PO no.);
- &Tradition item number;
- Description of the claim; and
- Photo documentation supporting the claim.

10.3.2. Any claims made subject to the warranty provisions must be notified &Tradition without undue delay and include same documentation as outlined in 10.3.1. and send by e-mail to aftersales@andtradition.com.

10.3.3. &Tradition reserves the right to reject any claims that do not meet the requirements as set out herein.

10.3.4. Insofar &Tradition approves the claim, &Tradition shall at its sole discretion determine its remedy whether to repair, replace the product or repay the purchase price. The Buyer is not entitled to make financial claims against &Tradition in cases of non-conforming products, unless where mandatory applicable law precludes or prohibits any exclusion or limitation of liability.

11. Warranty

11.1. &Tradition provides a two-year warranty on all standard products and five-year warranty on all standard furniture against defects in materials and workmanship. The warranties do not extend to situations and/or defects resulting from, without limitation, any of the following:

- Non-compliance with &Tradition's instructions for assembly, use, maintenance or care;
- Exposure to direct sunlight or heat from i.e. radiators that may fade and dry out surfaces on wood, fabrics or leather;
- Normal wear and tear, including without limitation deformation of foam, webbing, paper cord and rattan, or damage to upholstery; or
- Use of customer's own material (COM), other non-standard fabrics or leather not listed in &Tradition's pricelist on a specific product, or customer-supplied components.

11.2. The warranty will become void upon any alteration or repair of product on the Buyer's own initiative.

11.3. Tolerances

11.3.1. Variations naturally occurring in wood, leather, marble and other natural materials, as well as formation of wrinkles on leather and fabrics on upholstery products, are not considered defects in material or workmanship.

11.3.2. For products with LED light, reduction in light output may be expected over time.

11.4. Assembling and Maintenance Guides for Products

11.4.1. On www.andtradition.com instruction manuals, care and maintenance guides are available.

12. Product Compliance

12.1. &Tradition shall be responsible that any product delivered adheres to all laws and regulations applicable to the product within the delivery location at the time of delivery to the Buyer.

12.2. The Buyer undertakes not to export the products to countries where the products do not comply with the laws and regulations applicable to the products in respect to

without limitation materials, labelling, packaging, technical requirements etc. The Buyer shall indemnify and hold &Tradition harmless for any damage, loss or claim resulting out of or in connection with the Buyers breach thereof.

13. Force Majeure

13.1. &Tradition shall not be in breach nor liable for any delay in performing, or failure to perform, any of its obligations pursuant the Order if such delay or failure results from events, circumstances or causes beyond its reasonable control.

14. Governing Law and Jurisdiction

14.1. The Order, including these GTCs shall be governed by and construed in accordance with the laws of Denmark, excluding its conflicts of law provisions and the CISG.

14.2. Any disputes between the Parties arising out of or in connection with the Order and/or GTCs shall be settled by the City Court of Copenhagen.

15. All Rights Reserved

15.1. &Tradition is not responsible for any printing errors or price errors. &Tradition reserves the right to make changes or to discontinue any product or part thereof without prior notice.

16. Contact Information

16.1. &Tradition A/S, CVR-nr. 18169304, Kronprinsessegade 4, 1306 Copenhagen K, Denmark, +45 3920 0233, info@andtradition.com

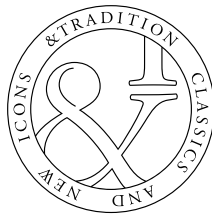

&Tradition
Anker Heegaards Gade 8
DK-1572 Copenhagen
info@andtradition.com
andtradition.com

©&Tradition 2024

#andtradition

&Tradition®